

My **BERNINA** Guide

807
810
817

Table of contents

	Page		Page		Page
Appliqué	43	Gatherer	41	Scissors holding	18
Appliqué with pre-embroidered material	48	Gathering of material	24	Seam finishing	15
Attachment table, Model 807 only	9	Hemmer	38	Seams for knitted fabrics	19
Automatic stitches	16	Hemstitching	48	Securing threads	14
Basting	26	Hemstitch needle	48	Setting stitch length	14
Blind hem stitch	25	Highly elastic seams	20	Sewing lamp, Model 807/810	4
Bobbin and bobbin case, Model 807/810	5	Inserting the bobbin	7	Sewing lamp, Model 817	5
Bobbin and bobbin case, Model 817	6	Inserting zips	35	Sewing elastic thread	24
Borders	22	Lace in material	23	Sewing on buttons	34
Border-scalloped	44	Lace on tricot	22	Shell hem	22
Border with reinforcing cord	45	Lap hemmer	40	Shell hemmer	39
Breakdowns	51	Looping	15	Stretch seam	20
Buttonholes	27–28	Lowering drop-feed control	8	Stretch stitch for hems on tricot underwear	20
Buttonholes with cord	28	Lycra seams	20	Straight stitching	14
Changing the presser feet	9	Marking	36	Tailor tacking	36
Cleaning and oiling, Model 807/810	52	Material gathering	24	Terry towelling darning	33
Cleaning and oiling, Model 817	54	Material patching	29	Thread correct holding	13
Corded buttonholes	28	Monograms	50	Thread cutter	9
Darning fine socks	31	Needle position	14	Thread table	6
Darning material with the automatic	29	Needle table	6	Thread tension	8
Darning material	30	Normal gathering	24	Threading upper thread	8
Darning sleeves	31	Oiling, Model 807/810	52	Trellis work with metallic thread	40
Darning terry towelling	33	Oiling, Model 817	54	Tricot hems	17
Darning woollens	33	Overlock	21	Tricot seams	19
Double hemstitch needle	48	Patching material	29	Tricot patching	18
Double needle	46	Patching tricot	18	Unpacking and packing, Model 807/810	4
Edgings	23	Perforating	36	Vari-Overlock	21
Elastic tape	22	Pintucking	47	Waving of tricot	17
Elastic thread sewing	24	Plain stitching	13–16	Winding lower thread	7
Electrical connection, Model 807/810	4	Quick seam	19	Wool darning	33
Electrical connection, Model 817	5	Reverse sewing	14	Wrapping	15
Faults	51	Ruffling	48	Zigzag sewing	15
Finishing edges	14	Satin stitch	10	Zip insertion	35
Finishing seams	15	Satin stitch	16		
Flat seam	19	Satin stitch embroidery	44		
		Scalloping	44		

Model 807, 810 Free-arm zigzag sewing machine with built-in plain and fancy stitches

Model 817 Flat-bed sewing machine with built-in plain and fancy stitches

General information

Max. zigzag width	4.5 mm
Stitch distribution	left—center—right
Max. forward stitch length	4 mm
Max. reverse stitch length	2 mm
Presser foot lift	6,5 mm
Passage space	110 × 200 mm
Size of baseplate	355 × 182 mm (807, 810)
Shuttle system	non-stick central bobbin shuttle
Bobbin capacity	75 m cotton yarn
Needle system	705 B
Thread tension	upper thread tensioning incorporated in frame cover
Winder	self-releasing
Motor	power: 85 watts
Sewing lamp (built-in)	power: 15 watts
Number of stitches	approx. 1100 stitches/min.
Weight of machine (807)	approx. 8,1 kg
Weight complete with carrying case (807)	approx. 12,2 kg

Important note (safety regulations BEAB, OSHA and so on)

Please observe the sewing position while sewing. The moving needle is a source of danger (danger of injury to fingers).

The sewing machine should be disconnected from the power supply by pulling out the plug from the socket when changing the light bulb, the needle, presser foot, bobbin or needle plate, when stopping work without supervision and during servicing (cleaning).

Name: _____

Address: _____

Date of delivery: _____ Machine No. _____

Dear Bernina Customer,

You are now the happy owner of a Bernina. We greatly appreciate the confidence you have placed in us and assure you that you will not be disappointed.

We have deliberately chosen the title «My Bernina Guide», because we are certain that this tuition book will become a very personal thing to you in association with your machine. Together with your book you will receive instruction from your Bernina dealer. Your samples of work can then be mounted on the red printed spaces provided and a valuable work of reference can thus be compiled.

Special attachments are required for some of the jobs described in this book. These can be supplied against extra charge. Your Bernina dealer will be glad to advise you.

As soon as you have mastered the sewing techniques taught to you during your instruction period you will discover that sewing with a Bernina is a pleasure.

We wish you every success.

Fr. Gegauf Ltd., Manufacturers of Bernina Sewing Machines
Steckborn TG / Switzerland

The various parts of the machine

Model 807

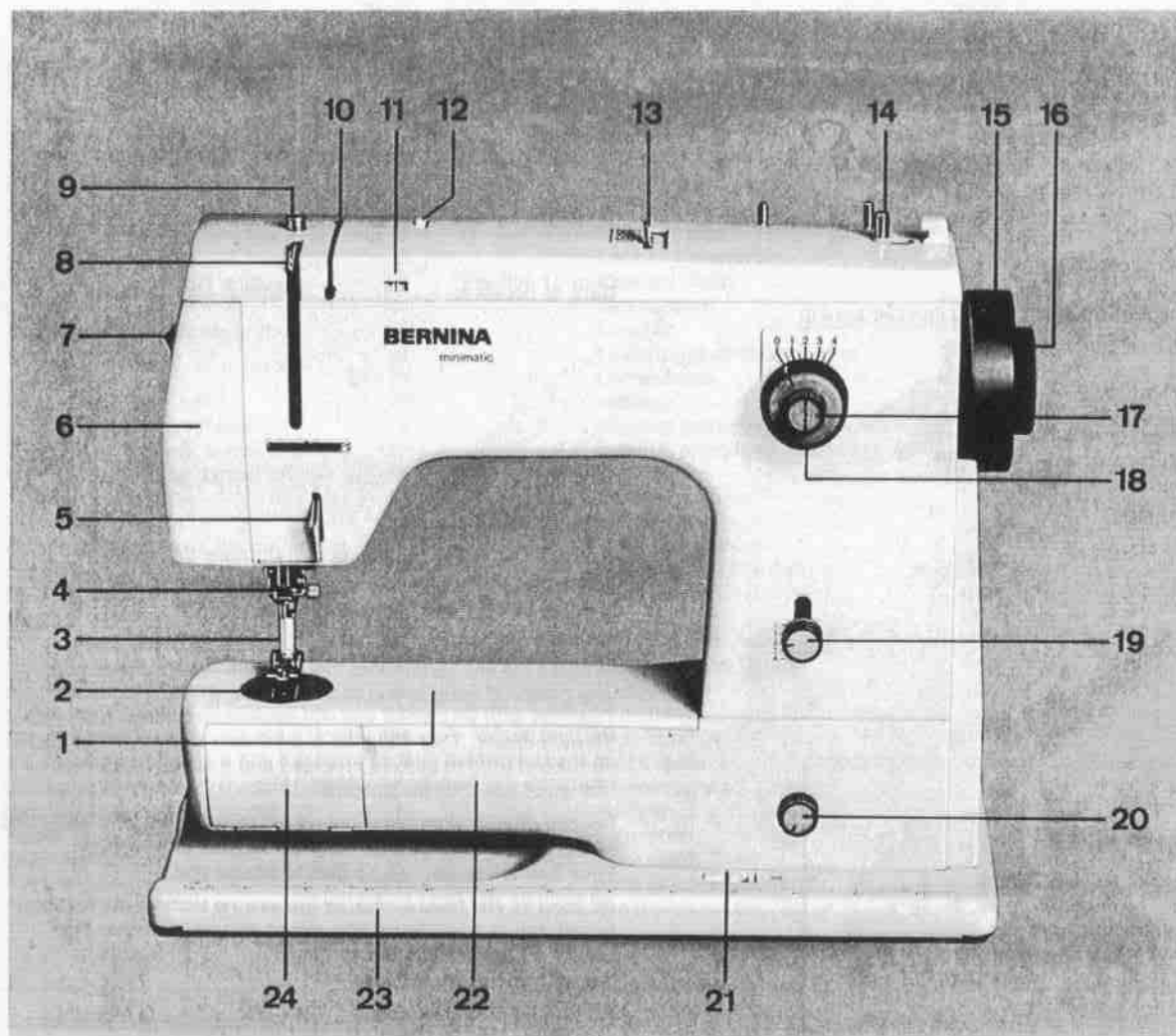

- 1 Free-arm cover-plate
- 2 Needle-plate
- 3 Presser-foot
- 4 Needle-clamp
- 5 Thread regulator
- 6 Face-plate
- 7 Lamp switch
- 8 Take-up lever
- 9 Winder pre-tension
- 10 Thread tension and thread guide
- 11 Tension indicator window
- 12 Thread tension control wheel
- 13 Selector lever for plain or utility stitch
- 14 Winder spindle
- 15 Handwheel
- 16 Handwheel release
- 17 Left-center-right adjusting knob (needle position)
- 18 Zigzag adjusting knob
- 19 Stitch length adjustment (stitch length lever)
- 20 Drop-feed control
- 21 «Fast-Slow Sewing» motor control
- 22 Free-arm
- 23 Base-plate
- 24 Hinged cover

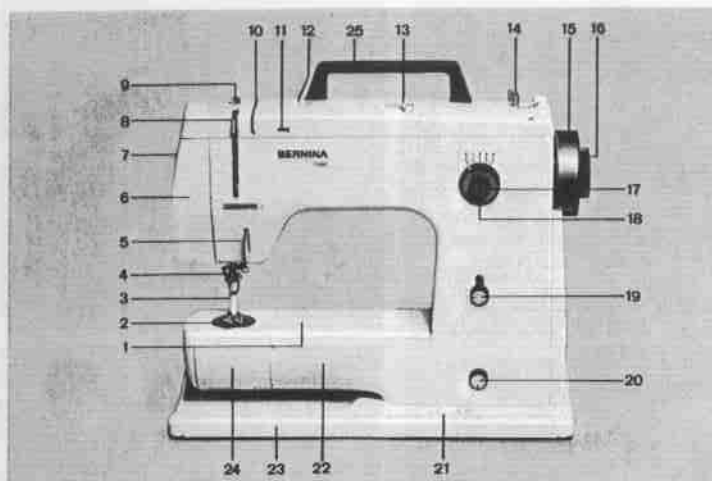

- | | |
|---|---|
| 1 Free-arm cover-plate | 15 Handwheel |
| 2 Needle-plate | 16 Handwheel release |
| 3 Presser-foot | 17 Left-center-right adjusting knob (needle position) |
| 4 Needle-clamp | 18 Zigzag adjusting knob |
| 5 Thread regulator | 19 Stitch length adjustment (stitch length lever) |
| 6 Face-plate | 20 Drop-feed control |
| 7 Lamp switch | 21 «Fast-Slow Sewing» motor control |
| 8 Take-up lever | 22 Free-arm |
| 9 Winder pre-tension | 23 Base-plate |
| 10 Thread tension and thread guide | 24 Hinged cover |
| 11 Tension indicator window | 25 Carrying handle |
| 12 Thread tension control wheel | |
| 13 Selector lever for plain or utility stitch | |
| 14 Winder spindle | |

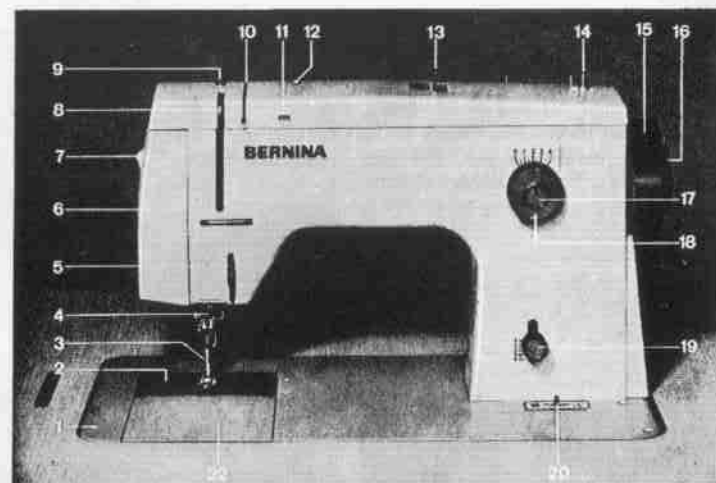

- | | |
|----------------------------------|---------------------------------|
| 1 Base-plate | 12 Tension centering wheel |
| 2 Needle-plate | 13 Pattern selector |
| 3 Sewing-foot | 14 Bobbin winder spindle |
| 4 Needle-clamp | 15 Handwheel |
| 5 Thread regulator | 16 Handwheel release |
| 6 Light cover | 17 Needle position control knob |
| 7 Light switch | 18 Knob for setting zigzag |
| 8 Take-up lever | 19 Stitch length regulator |
| 9 Bobbin winder tension | 20 Control knob for drop feed |
| 10 Thread tension discs and slot | 22 Needle-plate slide |
| 11 Tension indicator window | |

Model 807

Sewing machine, foot control and table are housed in the case.

To take the machine out of the case, place it upright on a table. When locks are opened, one side of the case can be pulled down. The machine can now be placed without difficulty wherever it is needed.

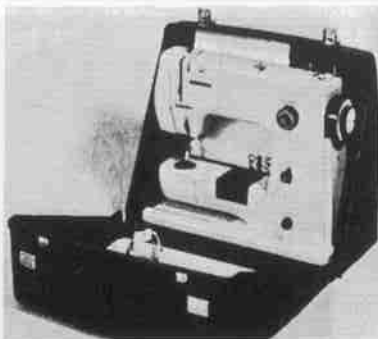

Model 810

For protection against dust, we have a cover made from reenforced material, which also has a side pocket for the instruction book (My Bernina Guide).



The container, which can be fitted on the free arm, is used to house the foot control unit, cable, and the box of accessories.

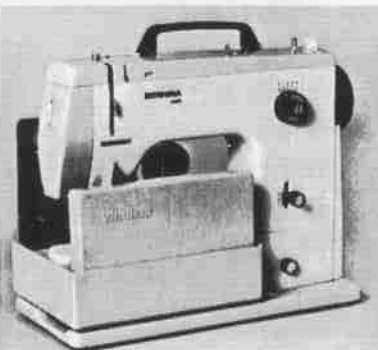

Connecting to supply

Warning! First compare voltage specified on machine with the existing mains voltage.

Fit special plug on foot-starter. After inserting the special combination plug for mains and starter connection in the machine, only then connect the mains plug with the socket and start the machine by pressing lightly on the foot-board of the starter.

Warning! The special connecting cable may only be used for connecting Bernina sewing machines.

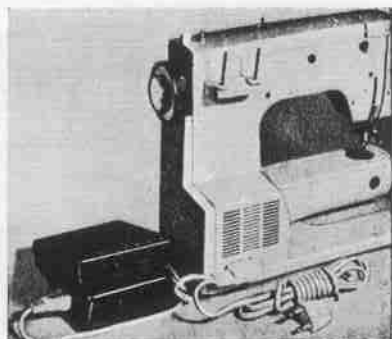

Variable speed motor. With many kinds of sewing it is an advantage to be able to work at reduced speed. Push switch to left. The machine then runs at half speed and it can easily be controlled within this range.

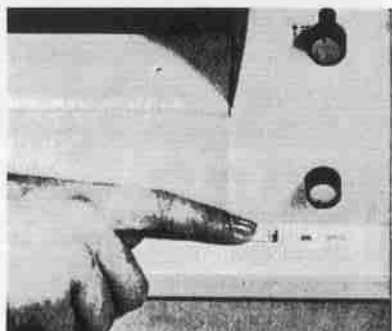

Light switch. By pressing switch the dazzle-free light can be switched on and off. Pull out light cover sideways to change the bulb. Press bulb upwards, turn anti-clockwise and draw downwards. To insert bulb, turn it clockwise.

Sewing lamp: 15 watts

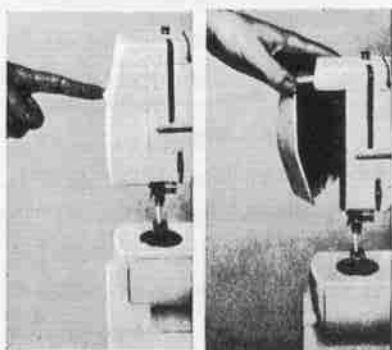

Connecting to supply

Warning! First compare voltage specified on machine with the existing mains voltage.

Fit special plug on foot-starter. After inserting the special combination plug for mains and starter connection in the machine, only then connect the mains plug with the socket and start the machine by pressing lightly on the foot-board of the starter.

Warning! The special connecting cable may only be used for connecting Bernina sewing machines.

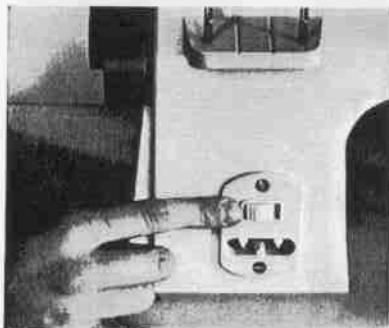
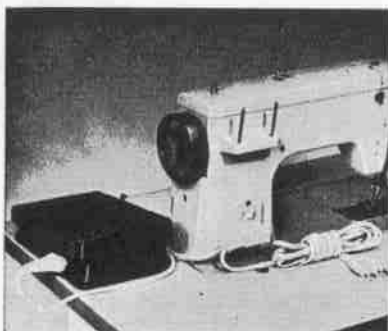

Adjustable motor. It is an advantage with many kinds of sewing to be able to reduce the speed of the machine. Push the switch. Now the machine runs with half the number of revolutions and the speed can easily be regulated.

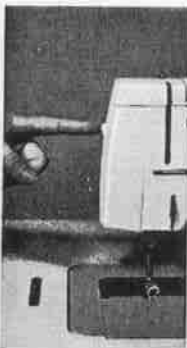

Light switch. By pressing switch the dazzle-free light can be switched on and off. Pull out light cover sideways to change the bulb. Press bulb upwards, turn anti-clockwise and draw downwards. To insert bulb, turn it clockwise. (Lamp: 15 Watt.)

Removing the bobbin case

Open hinged bobbin case cover. Turn hand wheel towards you until the needle is in its highest position.

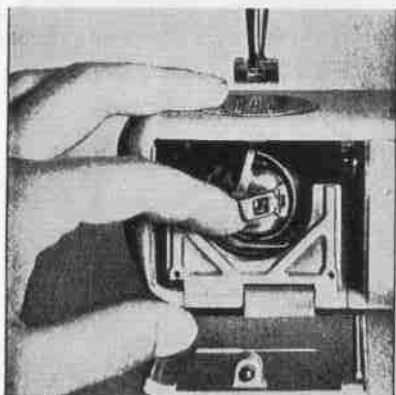
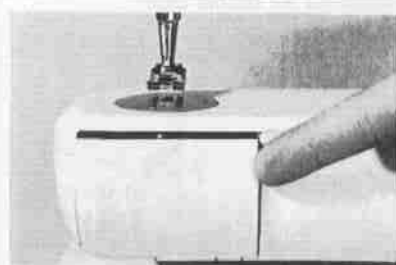

Open the hinged latch with thumb and forefinger of the left hand and remove the bobbin case. The insertion of the bobbin case is carried out in the same manner.

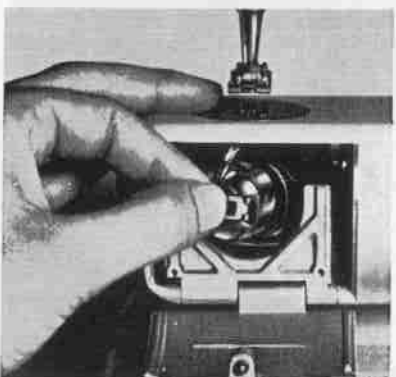

Removing the bobbin case

Open stitch plate slide. Turn hand-wheel towards you, until needle reaches highest point.

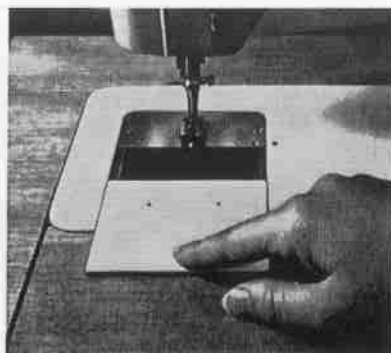

Open the hinged latch with thumb and forefinger of the left hand and remove the bobbin case. The insertion of the bobbin case is carried out in the same manner.

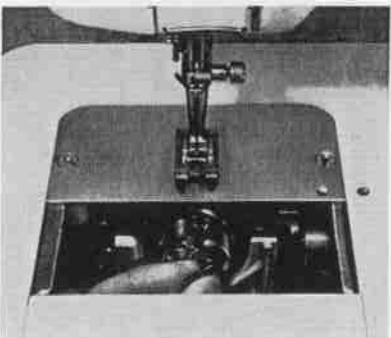
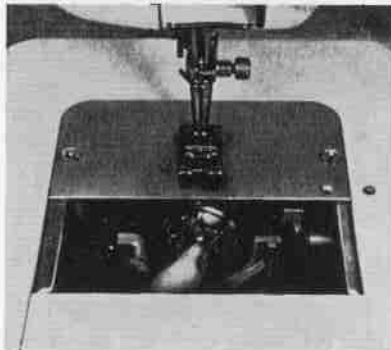

	very fine	fine	medium	strong	large
Needle system 705 B	60	70	80	90	100
Mercerised sewing thread (3 ply)		50	50	40	40
Darning thread (2 ply)	50	30—50	50		

Correct choice of needle and thread.

Use only needle system 705 B for Bernina sewing machines 807, 810 and 817. Please ensure that the needle and thread used conform to the table above. The usual needles for sewing are numbers 80, 90 and 100 while those for darning are numbers 70 and 80.

The presser foot with the white plate is a Bernina innovation. Set the needle with the handwheel high enough so that the eye of the needle is in front of the white surface. The eye becomes much more clearly visible and threading is thereby made considerably simpler.

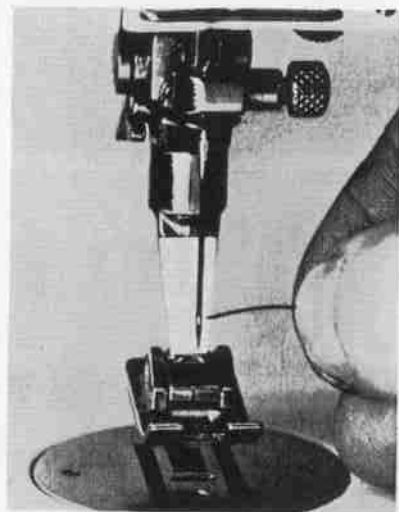

Winding of thread on bobbin

Release handwheel: hold handwheel with the left hand. Release handwheel with the right hand by turning the knurled screw.

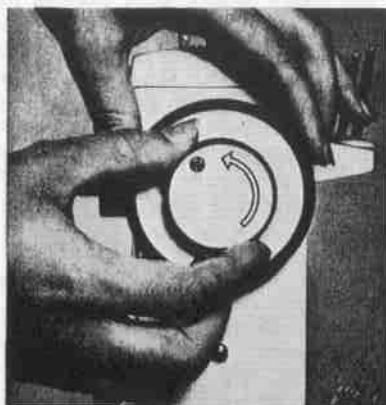

Place bobbin on winder spindle and press to the right. The winder is then switched on.

Draw thread from the reel clockwise round the pre-tensioning device (9) and from there — as shown in the picture — take to the mounted bobbin. Start motor with the foot starter.

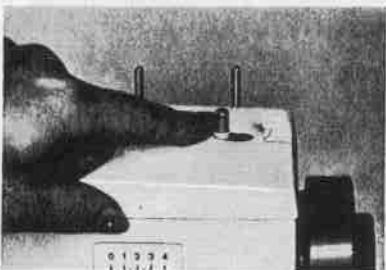

When the bobbin is full, the winding process stops automatically. Switch off motor, remove bobbin and push winder spindle back to left. Then re-tighten knurled screw on handwheel.

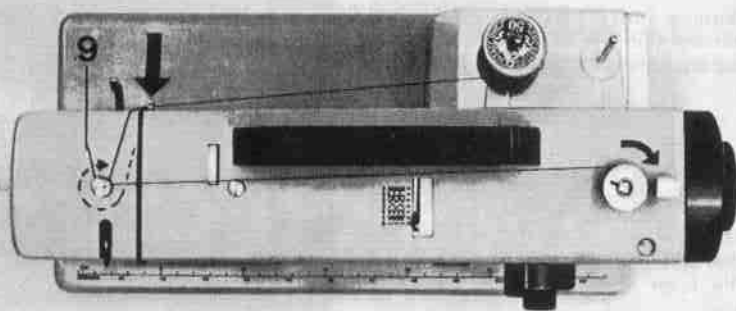

Inserting the bobbin

Insertion of bobbin into the bobbin case. When the bobbin is in the case make sure that the thread unwinds in the direction of the arrow.

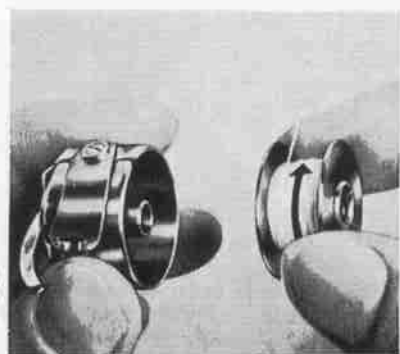

Draw thread through slot and then under tension spring. Do not hold the bobbin. The bobbin must turn in the direction of the arrow when unwinding.

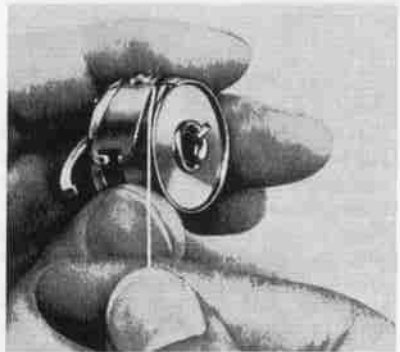

Insertion of the bobbin case into the hook. Raise needle to top position by turning the handwheel. As when removing the bobbin case hold it by the hinged latch with thumb and forefinger of the left hand. Hold bobbin case in such a way that the extension arm is directed upwards and fits into the niche of the hook race cover. Check-up: Pull end of thread.



To thread the machine

Fixing the needle. Loosen the needle clamp screw half a turn. Push the needle upwards as far as it will go with the flat side at the back and facing away. Tighten needle clamp screw.

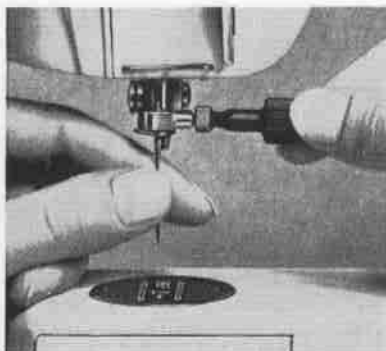

Threading the machine. The thread is led from the spool to the needle in one movement. Presser foot and take-up lever must be in their highest positions. Place spool on pin. Lead the thread with the left hand through the eyelet then pull it through the slot of the tension disc. With the right hand hold the spool steady.

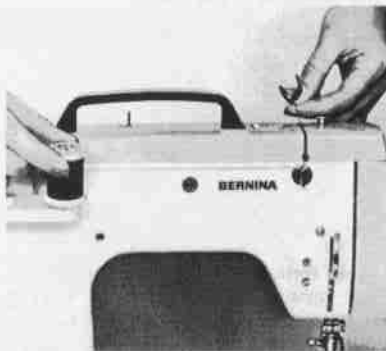

Now draw thread through the thread guide (5) up to the slot of the take-up lever (8) and again down to the needle eye. Thread the needle from the front to the back leaving a loose end of approximately 10 cm (4 ins.).

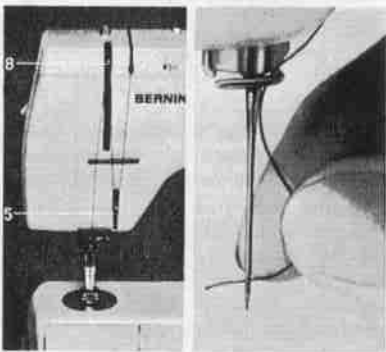

The thread tension discs. Bernina has the unique advantage that during normal sewing the thread tension does not have to be altered. The tension centering wheel (12) can be regulated for special purposes. For your guidance: Normal tension = black line in centre of window. + in centre = Tighter tension. — in centre = Looser tension.

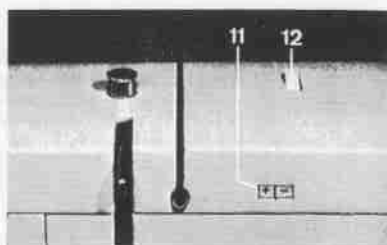

Bringing up the bottom thread. Hold needle thread loosely. Now turn the hand wheel towards you until the take-up lever is in its highest position. Pull the needle thread slightly and the bobbin thread will come up through the needle hole. Pull both threads under the presser foot and lay them there sideways.

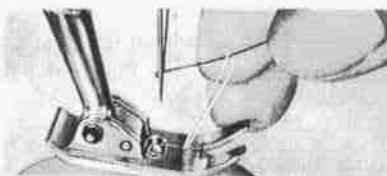

Lowering the feed dog. The feed dog must be lowered for certain kinds of sewing, mainly when darning.

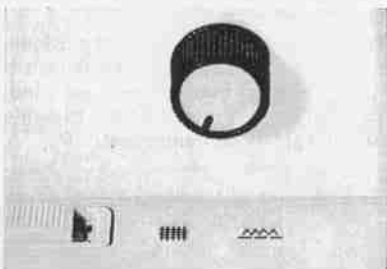

Model 807 and 810

Darning. Turn knob (20) to the left to the darning sign. For all normal sewing work the knob must be set to the sewing sign.

Model 817

Darning. Move lever (20) to the right to the darning sign. For all sewing work the lever must be set to the sewing sign.

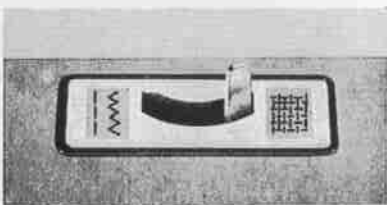

Removing work. It is essential to bring the take-up lever (8) into its highest position by use of the handwheel when sewing is finished. Raise presser foot by means of the lever at the back of the machine; this will release the top thread tension and the material can be removed easily by pulling to the rear.

Thread cutter. The lever on the presser foot bar is made in such a way that it can be used as a thread cutter. This small device helps to save time, especially when scissors are not close at hand.

Model 807 and 810

Fitting the attachment table. The attachment table is fitted in the case. It can be removed after turning the securing strap.

When sliding the table on the free arm, make sure that the locking lever is turned to the left. To secure the sewing table the lever must be turned to the right in the direction of the arrow.

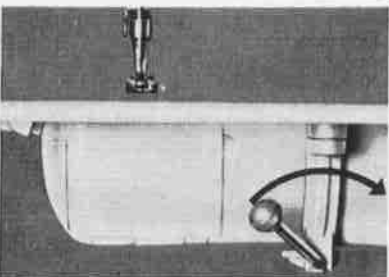
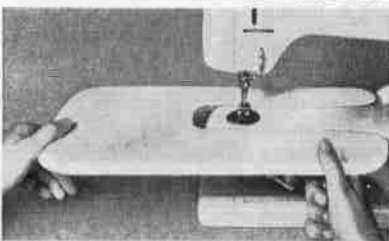
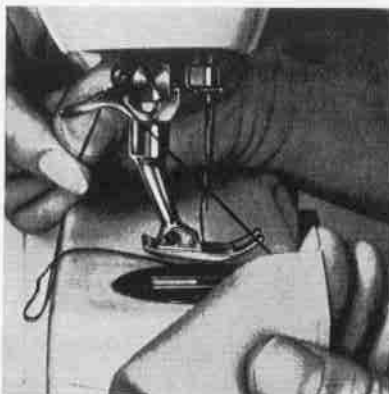

Use the correct presser foot for each type of work. Only in this way will you achieve easy and perfect work. The patented Bernina presser foot clamping lever permits quick and easy changes. The Bernina principle: «Just clip it on!» The work is done in no time.

Raise presser foot by using lifting lever

Loosen clamping lever and release presser foot

Fix the required presser foot on and push lever downwards. The presser foot is secured and the machine is ready for sewing. Only Bernina has this advantage.

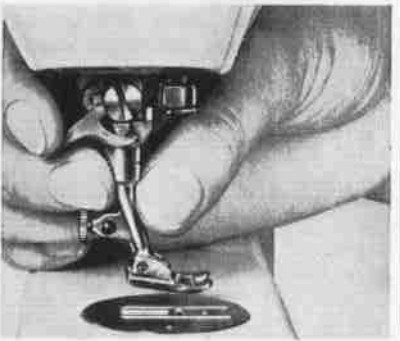
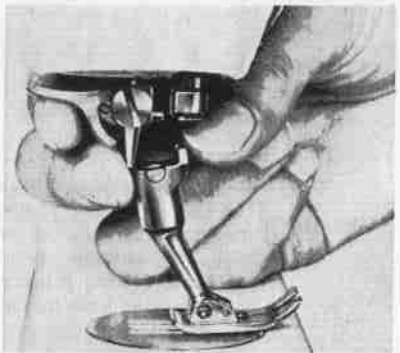

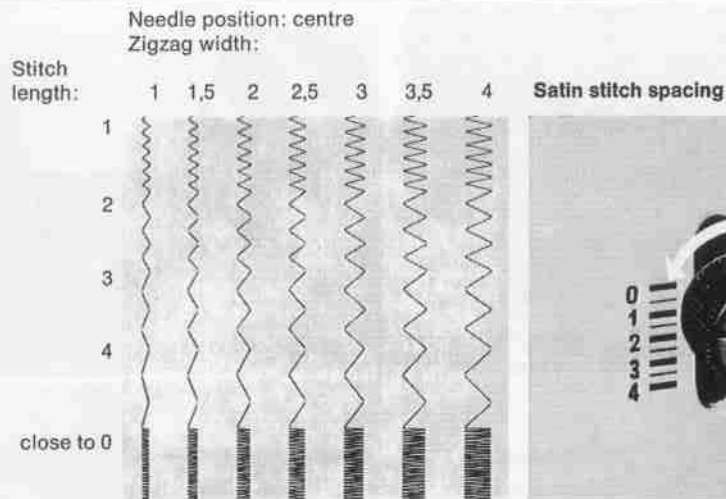

Zigzag sewing

Setting the zigzag spacing: knob 18. The line on zigzag 18 allows the stitch spacing to be read on the scale at the back. For straight stitching the knob position is at «0». If the knob is turned to the right — from 0 to 4 — the needle displacement becomes greater. The higher the number, the wider the zigzag stitch. The knob may be moved while sewing **but when the machine is stationary only if the needle is out of the material.**

The satin stitch spacing can be accurately adjusted with the stitch length adjusting knob (19). Turn knob (19) clockwise to the right until it stops. The marker line on the knob is vertical (stitch length = «0»). You can then adjust the satin stitch spacing — depending on material and thread — by turning the knob to the left.

The various plain stitches which can be sewn with the Bernina Models 807, 810 or 817.

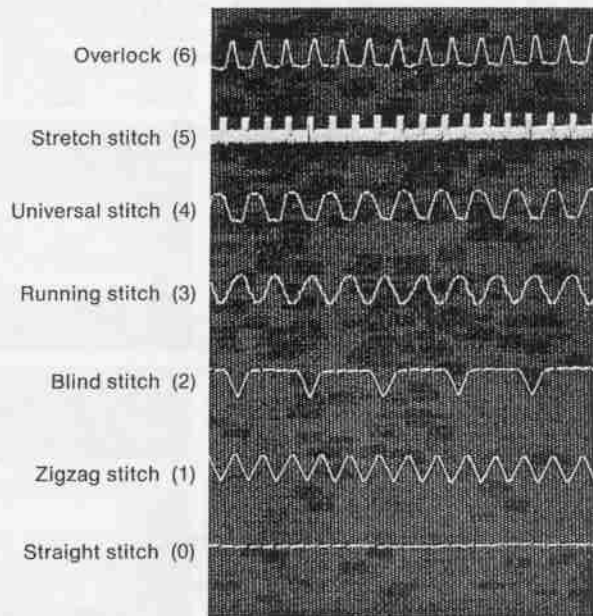

Buttonhole gauge / Hem gauge

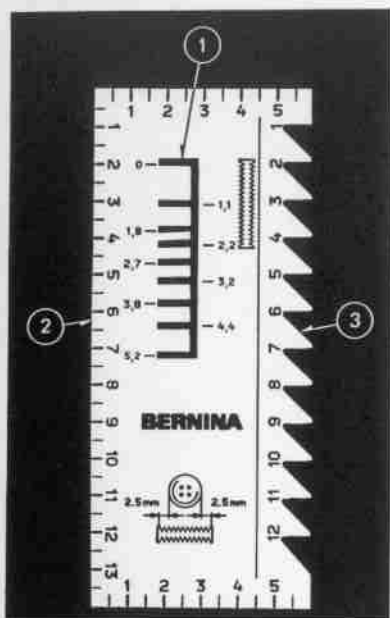

- 1 Buttonhole gauge
- 2 Ruler
- 3 Hem gauge

The plastic gauge which is enclosed with the accessories can be used as a ruler, as a hem gauge, or as a gauge for marking the length of buttonholes.

Marking of buttonholes

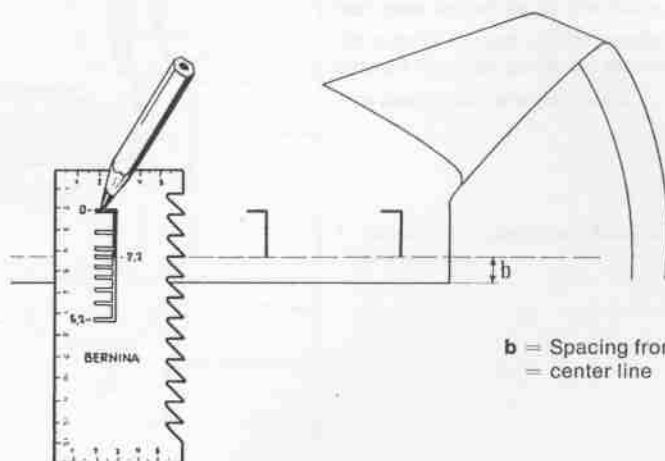

b = Spacing from
= center line

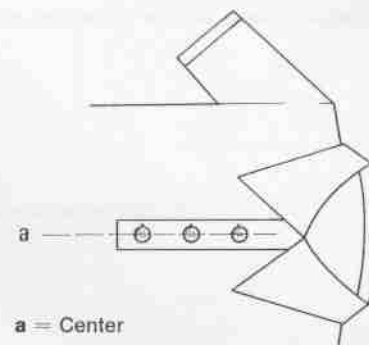

a = Center

Example: For button with a diameter of 2 cm ($\frac{4}{5}$ ") a buttonhole with a length of 2,2 cm ($\frac{9}{10}$ ") is marked.
(For spherical buttons a little bit more.)

Marking the width of hems by means of the hem gauge.

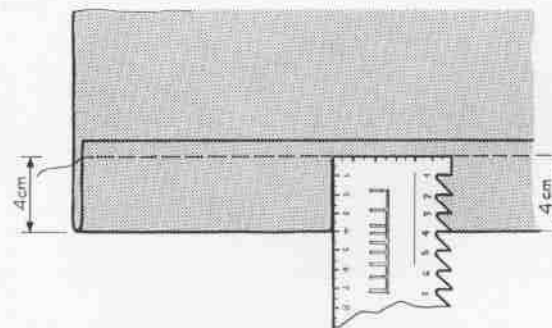

Some technical hints

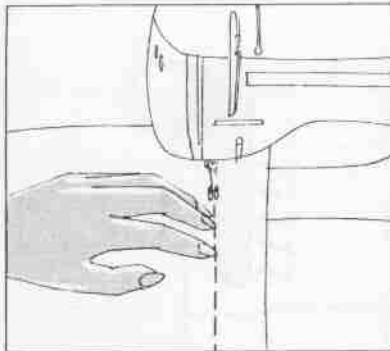

If you like to work as comfortably as possible we would advise you to observe the following points:

Place your Bernina far enough from the table edge (about 5 inches) for you to lean your left elbow on the table.

Sit exactly in front of the needle bar. The mastering of your sewing depends only on how you guide the material.

The basic rules are therefore:

1. Guide the material as close as possible from the side, and near the presser foot

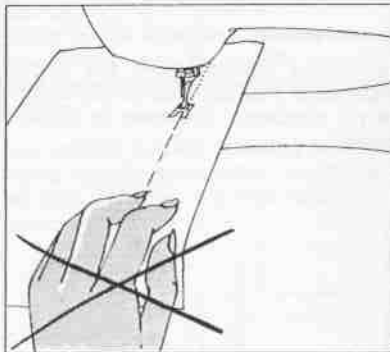

2. not from the front

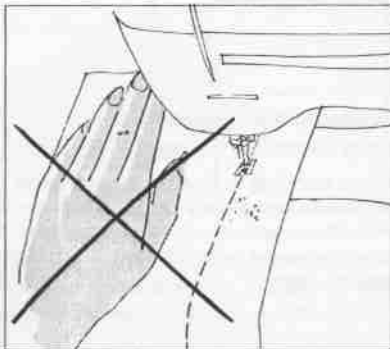

3. and not with the hand flat. Nor must the material be pulled to the rear.

Straight stitching

Zigzag foot 000

Needle:
normally 80
ad times 70-100
depening on the
material and thread

Thread:
adapted to the
fabric sewn

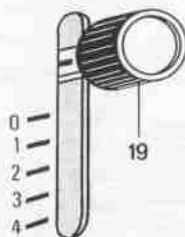
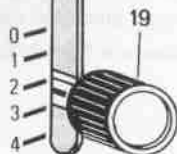

left centre right

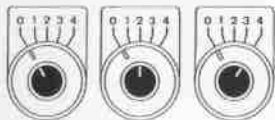

Needle Position

With the needle position knob the needle can be set at right or at left for buttonholes, blind hemming, zips, etc.

For normal sewing the needle remains in the centre.

Straight stitch

Stitch width: 0
Stitch length: 1-4
Needle position: centre
Drop feed control: sewing
Automatic: straight stitch ----- (0)

Set stitch length lever at desired length.
Normal stitch length: about 1½-2

Reverse sewing

For reserve sewing, move the stitch length lever (19) upwards (where there are no numbers). The lever is spring loaded.

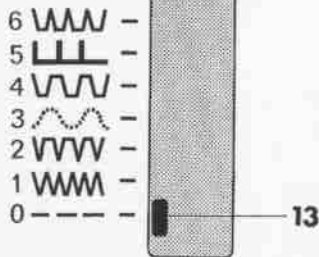

Securing in thick seams

(Stitch length not too short.)

Before stitching in reverse always leave the needle completely down in the material, then move lever to reverse sewing. The same applies when sewing forward again.

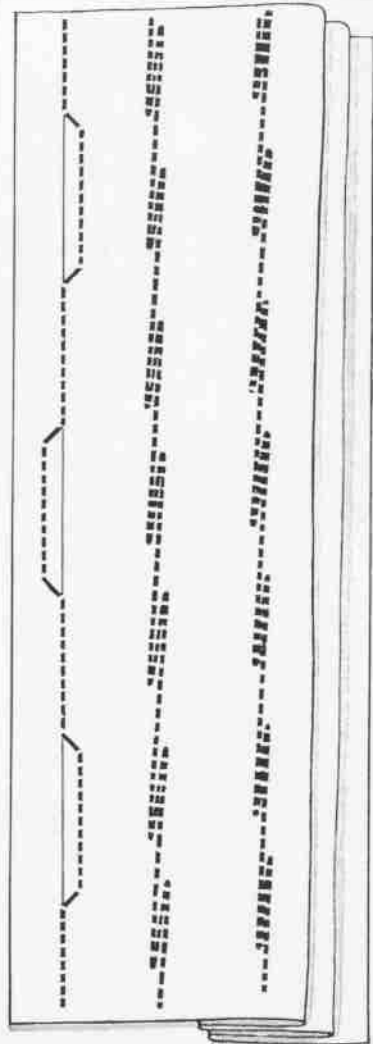

Zigzag foot 000

Needle:
normally 80
at times 70–100
depending on the
material and thread

Thread:
adapted to the
fabric sewn
if possible 50

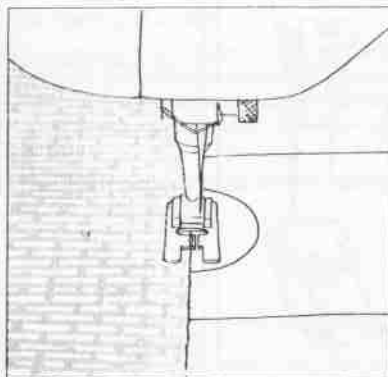
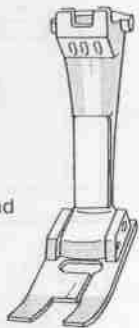

Guide the cut edge under the **centre** of the foot so that the needle actually goes once into the material and once outside.

As a general rule the following is valid:
zigzag not too wide, stitch length not too long. First trim the edge neatly.

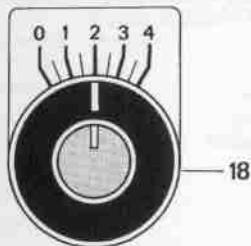

18

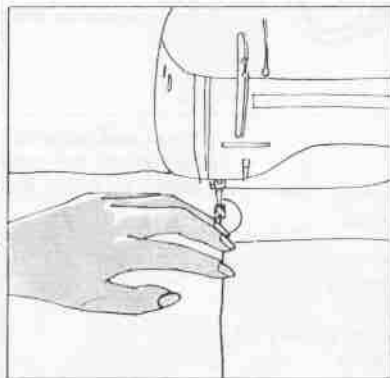

If you guide the work like this: From the front, close to the foot, fingers on the edge, you will easily get a neat finish.

Zigzag sewing

Set zigzag width according to work and material.

Finishing Edges

Stitch width: $2\frac{1}{2}$ –4
Stitch length: 1–2
Needle position: centre
Automatic: zigzag WWWW (1)
Drop feed control: sewing

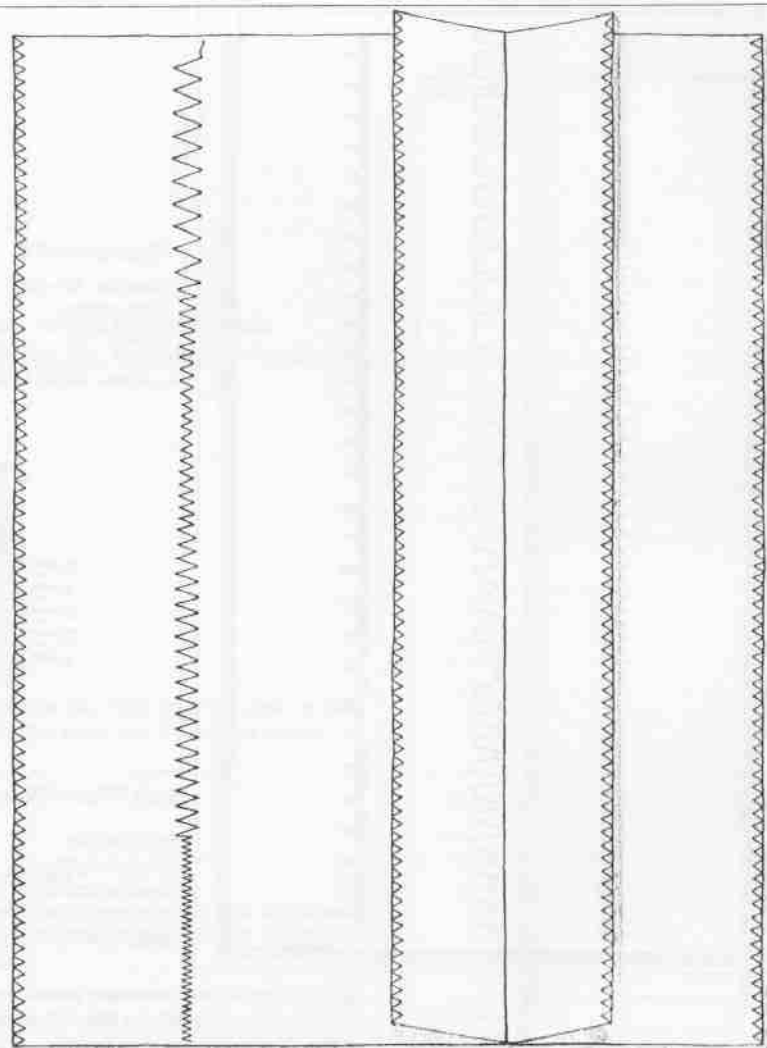

Automatic stitches

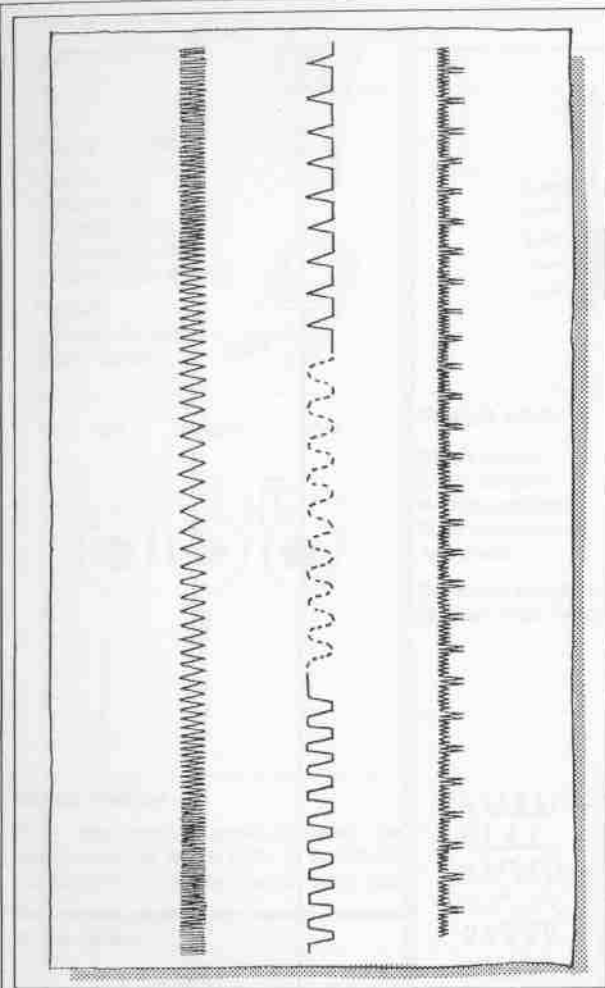

Zigzag foot 000
Needle: 80–70
Embroidery
thread: 30

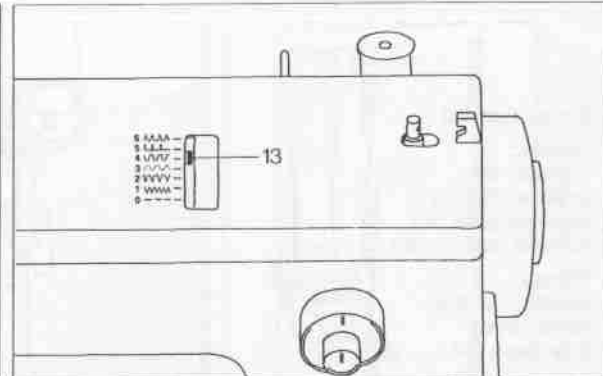

Automatic

Pull lever 13 to right and set it next to desired pattern. When doing this do not leave the needle down in the material.

Stitch width: 4
Stitch length: 1
Needle position: centre
Drop feed control: sewing
Paper underlay when needed

When embroidering it is advisable to lay paper underneath to prevent the material from puckering. (Do not use tissue paper, as this is too soft. Typewriting paper is excellent.)

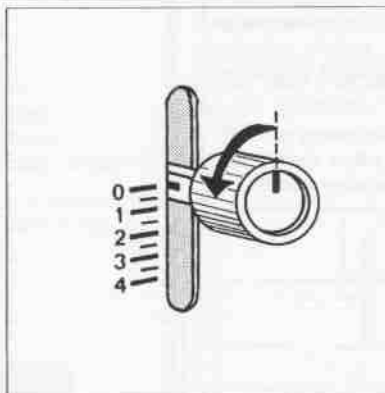

Satin Stitch (Close zigzag)

Stitch width: 4–1½
Stitch length: almost 0
Needle position: centre
Automatic: zigzag WWWW (1)
Drop feed control: sewing

The satin stitch spacing can be accurately set by turning the stitch adjustment knob (19) from stop «0» to the left (direction of arrow). (See also page 10)

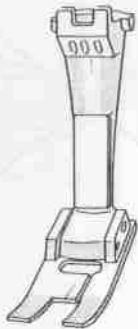

Zigzag foot 000

Needle: 80-70

Thread:
30 or 50

Hems for Jersey underwear

Needle position: centre
Automatic: zigzag WWWW (1)
Drop feed control: sewing

Single turned-in hems

Stitch width: 3
Stitch length: 1½

Double turned-in hems

Stitch width: 2½
Stitch length: 1½

The Waving of Jersey

To prevent the Jersey from waving, guide an extra thread inside the zigzag. (Not only for hems but whenever jersey stretches, e.g. patching, oversewing, etc.)

Press with a damp cloth before removing the extra thread.

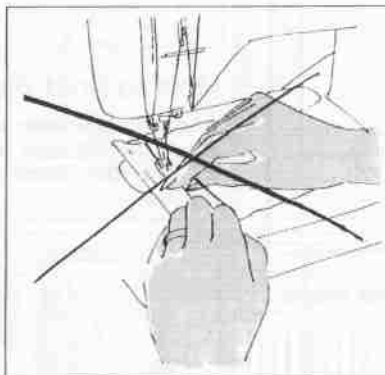

How to hold the extra thread

Not like this, because you obscure your view of the work.

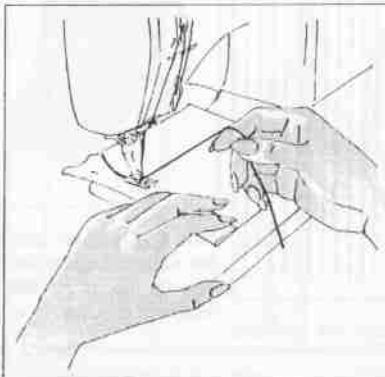

But like this: This way the view is clear and the work can be guided easily.

Important

Hold the thread slightly taut while sewing and the Jersey will not stretch so much.

The thread can also be guided through the hole in the needle plate like pintuck cord. (Especially useful for a large patch.)

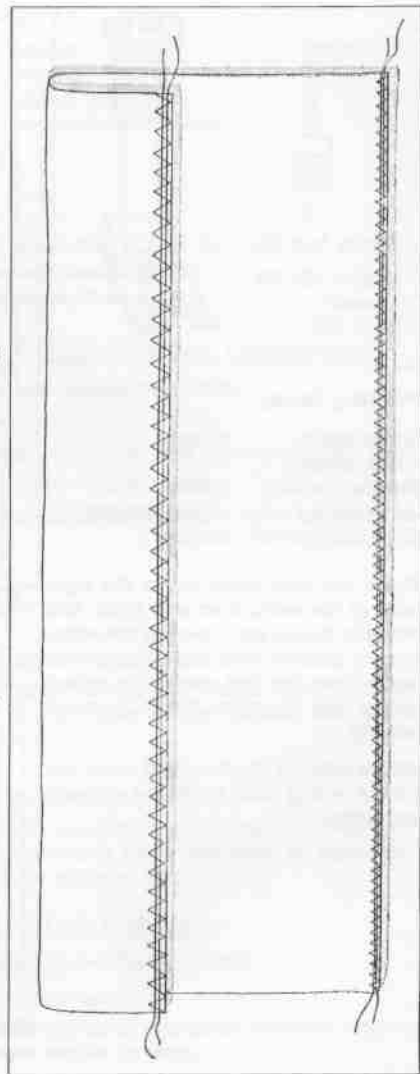

Patching Jersey



Zigzag foot 000

Needle: 80-70

Thread:
30 or 50

Patching Jersey

Stitch width: about 3

Stitch length: 1-1½

Needle position: centre

Automatic: zigzag WWWW (1)

Drop feed control: sewing

Baste the new piece on to the right side of the work, then sew it on, first with the zigzag just covering the edge, then a second time one presser foot width from the first seam. For cotton Jersey use the extra thread to avoid waving.

Afterwards cut the damaged piece out on the wrong side. (Hold the scissors correctly.)

Whenever possible make the patches in round shapes.

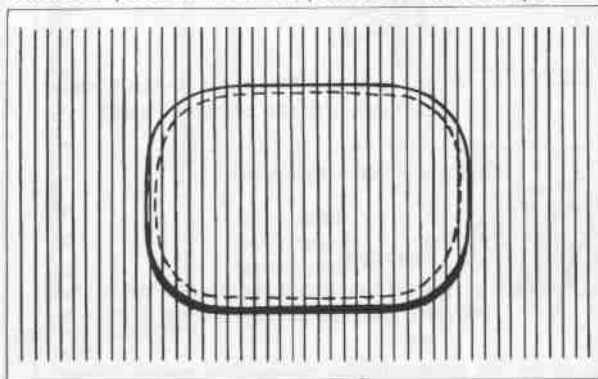

When square patches are unavoidable at least the corners should be rounded.

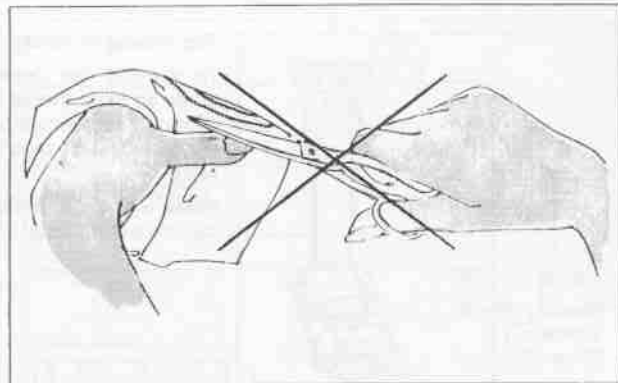

How to hold the scissors

Whenever you have to trim close to a zigzag the scissors should **not** be held like this (with the backs of the hands towards you). There is a risk that you might cut into the stitches.

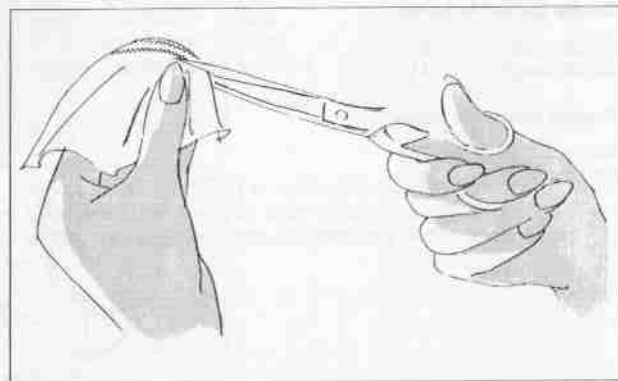

This way is much easier. **Palm of the hand towards you holding the scissors quite flat!!!** Cut only with the tips of the scissors. The thumb of the left hand should be close to the seam just where the scissors are cutting.

Elastic seams on Jersey

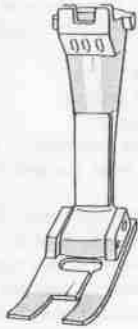

Zigzag foot 000
Needle: 80-70
Thread: 30

Four important points when sewing Jersey

1. Baste always with darning thread.
2. Use only a perfect needle. A blunt needle leaves holes.
3. Use fine mercerised thread.
4. Press each seam after sewing and not all seams together when the work is completed.

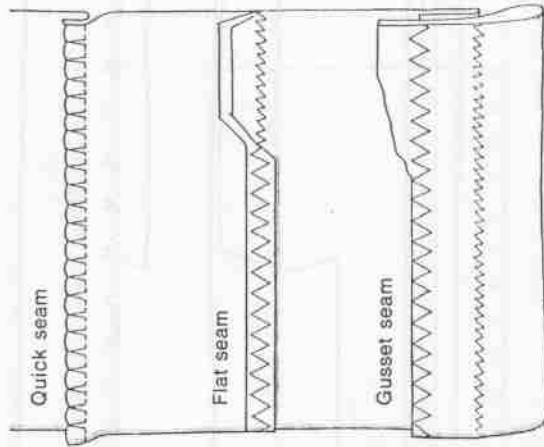

Quick seam

Flat seam

Gusset seam

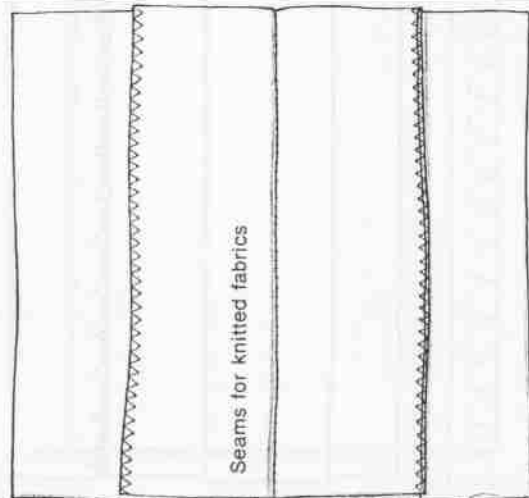

Seams for knitted fabrics

Seams on Jersey

Needle position: centre
Drop feed control: sewing
Automatic: zigzag WWWW (1)
except for quick seam

Quick seam

Stitch width: 3-4
Stitch length: 1/2-1
Automatic: Blindstitch [VVV] (2)

**Joins up and oversews simultaneously.
Important! Cut edges must be on left.**

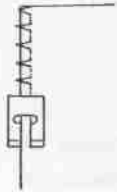

Flat Seam – Cotton Jersey Underwear

1st run: join up at **one presser foot width.**

Stitch width 1: Stitch length: 1-1 1/2

2nd run: press seam open and sew over it on right side.

Stitch width 3: Stitch length: 1-1 1/2

To finish off cut the remaining material. Hold the scissors correctly.

Gusset Seam

1st run

Stitch width 1: Stitch length: 1-1 1/2

Pin the pieces together leaving the double layer (gusset) protruding about 1/4 inch. **Sew at one presser foot width from the inner edge.**

2nd run

Stitch width 3: Stitch length: 1-1 1/2

Press the whole seam towards single layer of Jersey and **sew at one presser foot width along first seam on right side.** Trim off turnings. Hold scissors correctly.

Seams for Knitted Fabrics : Dresses – Skirts – Sweaters

Stitch width 1: Stitch length: 1

Knitted fabrics can be joined up like other materials. Seams are pressed open but remain stretchy.

Very elastic seams

Presser foot 000

Needle: 80

Thread:
Mercerised sewing
thread 50 or 60/3

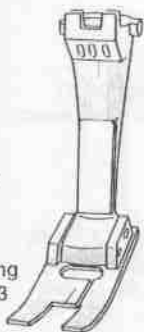

Flat joining seam

Especially for Lycra fabric
(e. g. Girdles)

Stitch width: $2\frac{1}{2}$
Stitch length: $\frac{1}{2}$ – $\frac{3}{4}$
Automatic: Universal stitch
 (4)
Needle position: center
Feed control: MM

Lay cut edges approximately $\frac{1}{4}$ " over each other, then oversew edges.

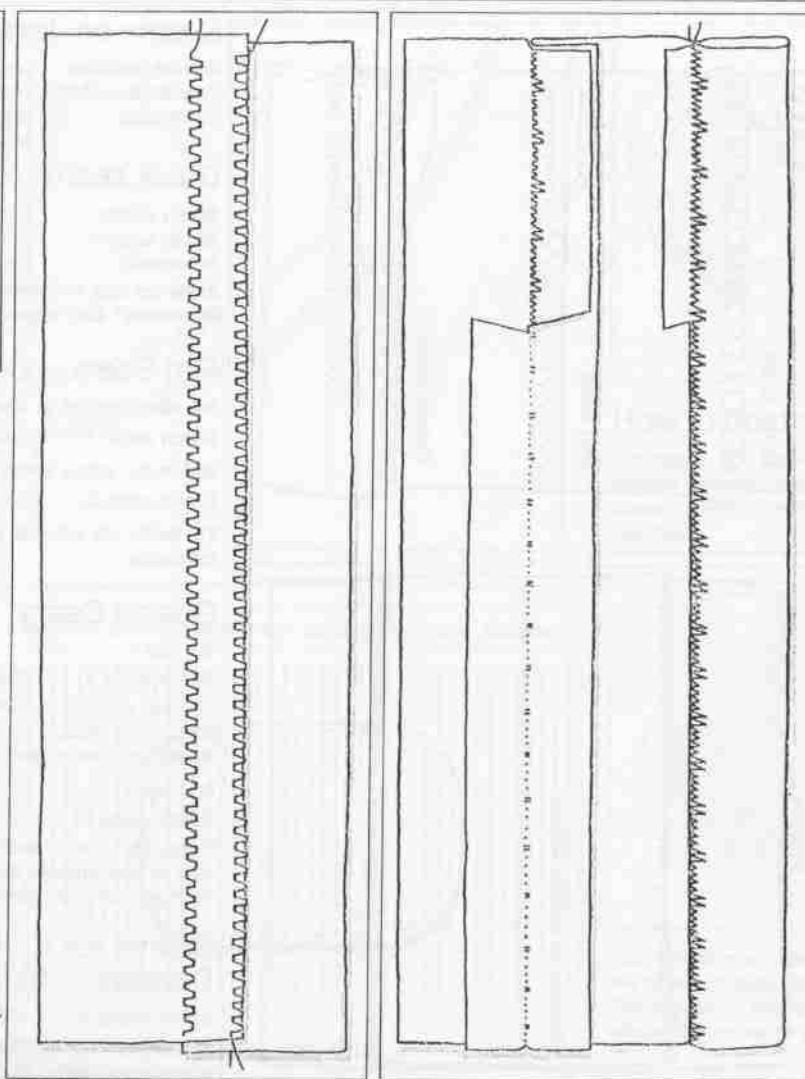

Stretch seam

for ski trousers and very elastic fabrics like Helanca[®], Crimplene, etc.

Stitch width: 1 – $1\frac{1}{2}$
Stitch length: $\frac{1}{2}$ – $\frac{1}{3}$
Automatic: Stretch seam (5)
Needle position: center
Drop feed control: On sewing

Sew tacked seam. (Lay the work under the presser foot in such a way that the somewhat wider zigzag stitch is directed towards the cut edge.) Press seam open and if necessary neaten.

Stretch seam as hem

only for Jersey underwear.

Stitch width: 3 – 4
Stitch length: approx. $\frac{3}{4}$
Automatic: Stretch seam (5)
Needle position: center
Drop feed control: On sewing

Iron hem. (Do not turn under the edge.) Measure depth of hem and then sew. (Lay the work under the presser foot so that the somewhat wider zigzag stitch is directed towards the edge of the hem.) Finish by cutting away surplus fabric on the sewn edge.

Overlock foot 470

Needle: 80-70

Sewing thread:
depeding on type
of material



The following point must be observed
with overlock sewing:

Please set automatic adjustment lever
(13) exactly to overlock symbol (No. 6).

**Synthetic fabrics should always be
sewn with a synthetic thread.**

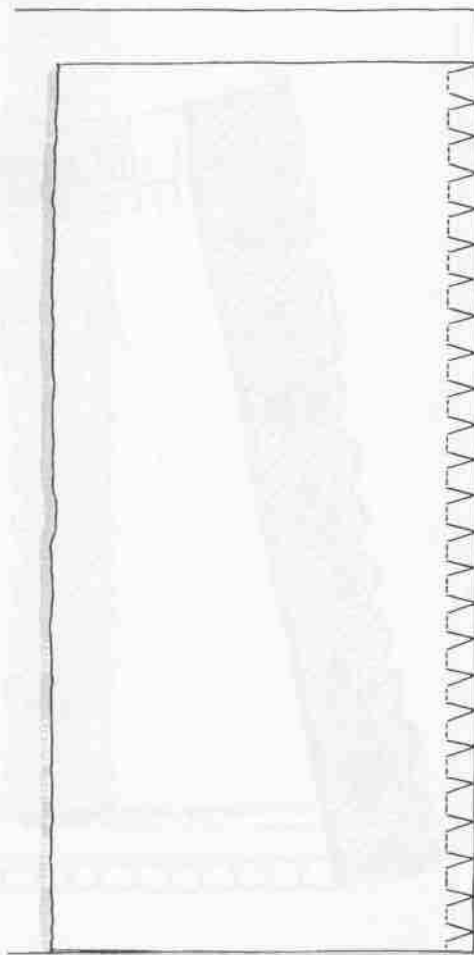

Overlock seam

Stitch width: (# 18)	4 (only)
Stitch length: (# 19)	1-1½
Automatic unit:	overlock (6)
Needle position:	right
Feed-dog:	at sew

The overlock seam is used for sewing
together and trimming.

Warning: material edge must lie to the
right.

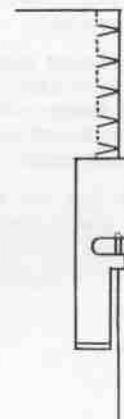



Zigzag foot 000

Needle: 80-70
Thread:
30 or 50

Shell Edging

Stitch width: 4
Stitch length: 1
Needle position: centre
Automatic: Blindstitch (VV) (2)
Drop feed control: sewing

Place folded edge to the **left** as for quick seam.

Elastic Band

Stitch width: 3
Stitch length: 1-1½
Needle position: centre
Automatic: zigzag WWW (1)
Drop feed control: sewing

Do **not** pull the elastic while sewing. The zigzag stitch stretches as much as the elastic.

The easiest way when sewing Jersey is to gather it up first, sewing long straight stitches, then draw the under thread and pull work up to desired length.

After this, pin on the elastic and sew it with zigzag. Trim off surplus material on the wrong side. (Hold the scissors correctly.)

Lace on Jersey

Stitch width: 1½-2
Stitch length: ¼-½
Needle position: centre
Automatic: zigzag WWW (1)
Drop feed control: sewing

Pin or baste lace on and sew straight on with zigzag. Trim off surplus on wrong side along zigzag. Hold the scissors correctly.



Zigzag foot 000

Needle: 80–70

Thread: 50

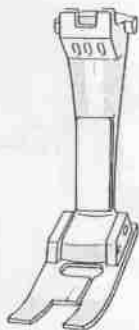

Lace (and insertion) in material

Needle position: centre
Automatic: zigzag WWWW (1)
Drop feed control: sewing

1st run

Stitch width: 0
Stitch length: about 1

Pin in lace, baste it and sew on with straight stitch

2nd run

Stitch width: $1\frac{1}{2}$ – $2\frac{1}{2}$
according to lace
Stitch length: about $\frac{1}{4}$ – $\frac{1}{2}$

Fold turning to wrong side against straight stitch and press. Sew a zigzag seam over the straight stitch. Then cut off the turnings along the zigzag seam. Hold the scissors correctly.

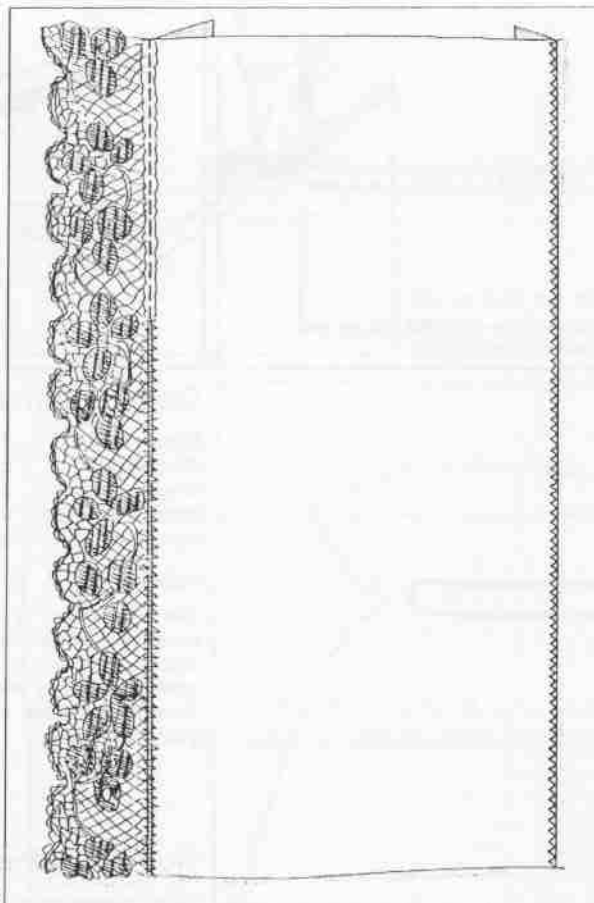

Narrow edging

Stitch width: about $1\frac{1}{2}$ –2
Stitch length: about $\frac{1}{4}$ – $\frac{1}{2}$
Needle position: centre
Automatic: zigzag WWWW (1)
Drop feed control: sewing

Prepare and press turnings. Sew zigzag over this pressed edge as for oversewing. (Guide work as for oversewing.) Finally trim away turnings. Hold scissors correctly.

Elastic thread

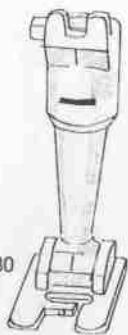

Embroidery foot 030

Needle: 80
Thread: 30

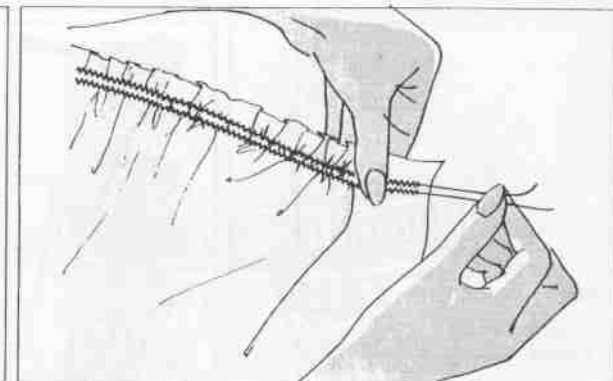
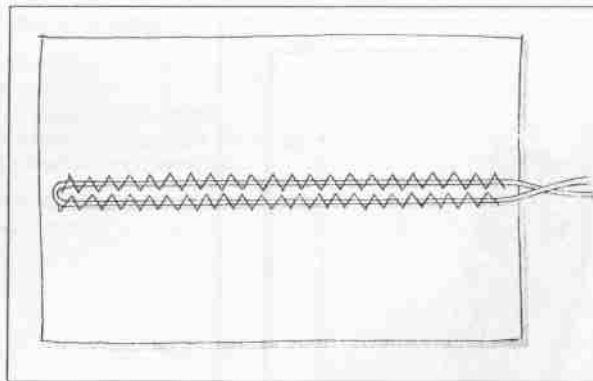

Applying elastic thread

Stitch width: 2
Stitch length: 2
Needle position: centre
Automatic: zigzag WWWW (1)
Drop feed control: sewing

Thread the elastic through the hole in the embroidery foot and pull it while sewing. The more you pull the more it gathers. For a second row (one presser foot width) **pull material straight while sewing.**

When doing it on socks do not pull the elastic too much.

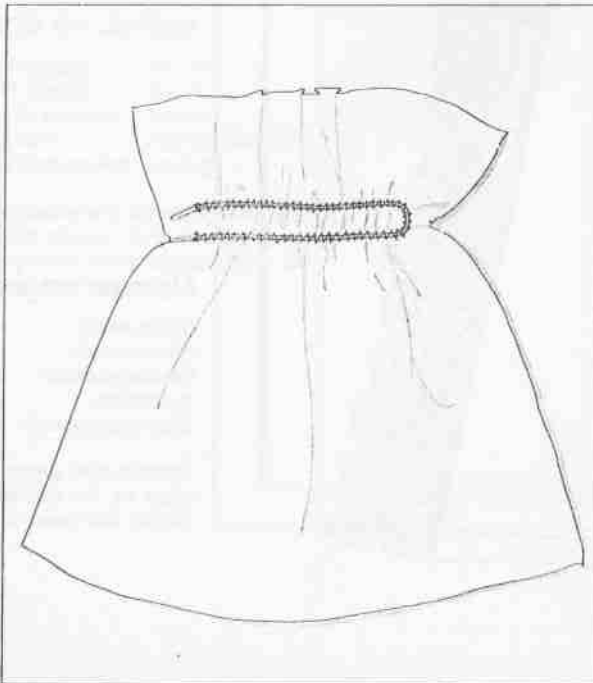

Gathering of material

Gathering material

Stitch width: 2
Stitch length: 2 (for heavy fabrics up to 4)
Needle position: centre
Drop feed control: sewing
Automatic: zigzag WWWW (1)

Pearl Cord

The pearl cord is threaded through the hole of the embroidery foot (as with elastic thread) and oversewn with zigzag. Contrary to elastic, the cotton is not pulled while sewing but only **afterwards.** (Hold both yarns and gather material.) Always sew two rows at a distance of 2 mm (1/8 inch.).

Normal gathering

Short pieces or sheer fabrics can also be gathered in this way:

Stitch width: 0
Stitch length: 4

Sew two rows of straight stitch, then hold both bottom threads and gather up to the desired width.

Blindstitch foot 016

Needle: 80-70

Thread: 30 or 50

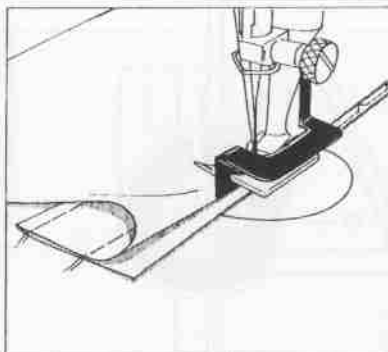
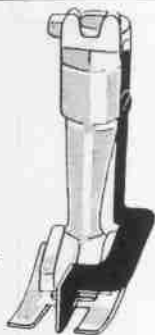

This is how the work is placed under the foot. Adjust the zigzag so that the needle just catches the **edge** of the fold.

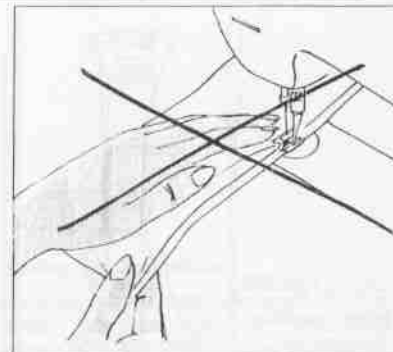

Very poor position.

Basic Setting

Stitch width: about 2½
 Stitch length: about 2½
 Needle position: right
 Drop feed control: sewing
 Automatic: Blindstitch  (2)

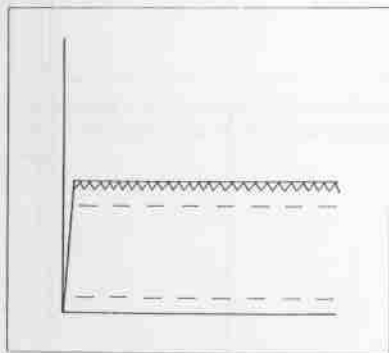

Oversew and prepare the hem as diagram, baste with machine or by hand ¼" from edge and press.

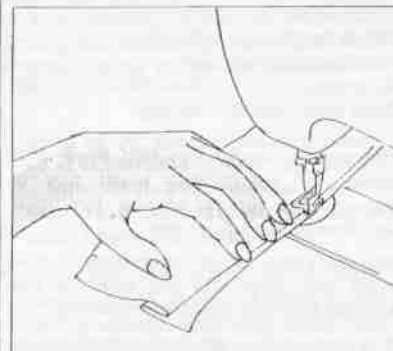
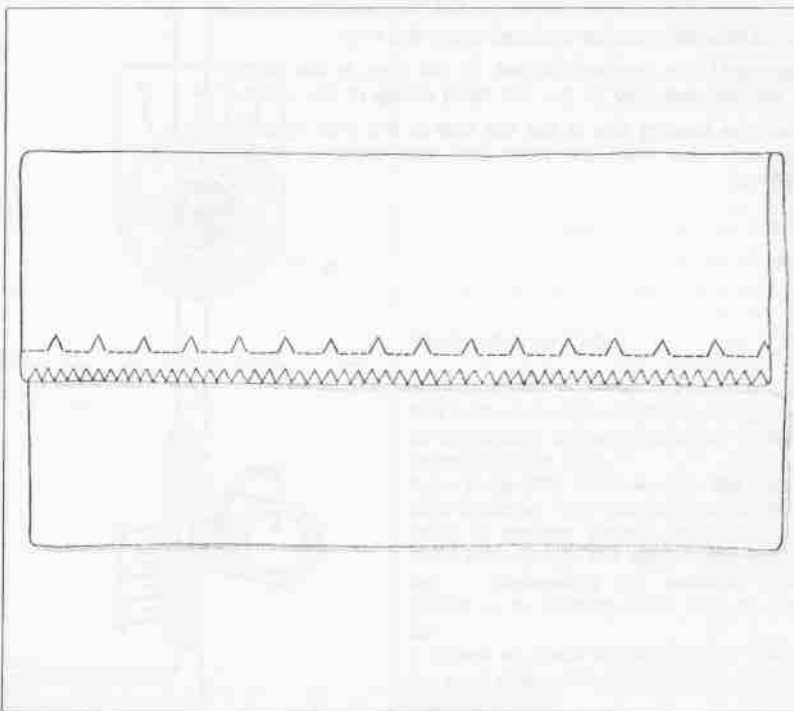

This is the correct way. Fingers of left hand must lie on the folded edge so that they can "feel" the regular feeding of the work. Hold the work very lightly while sewing.

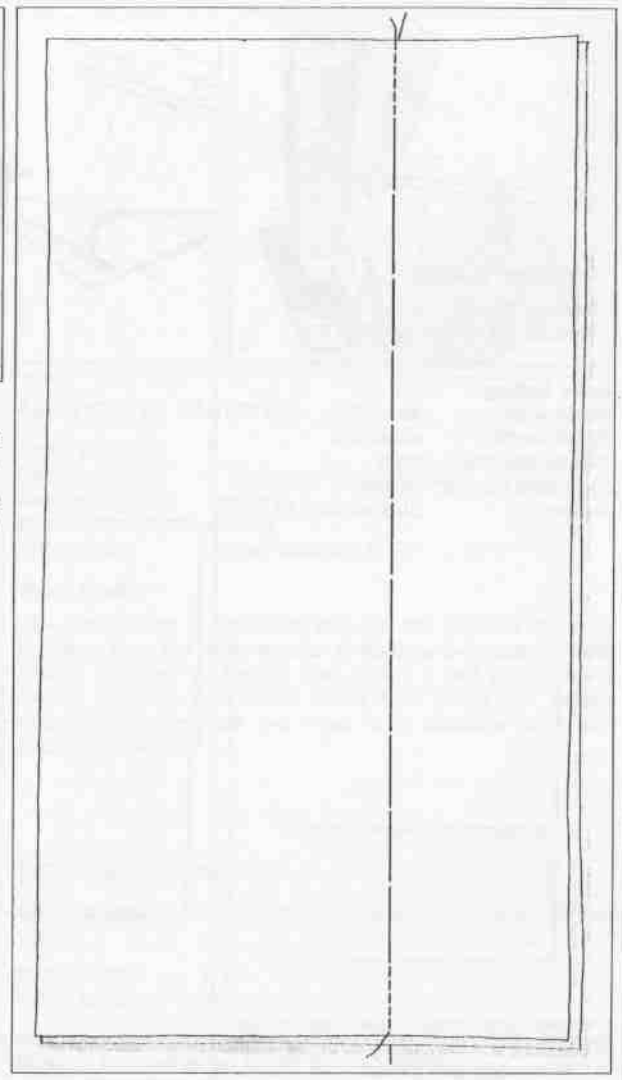
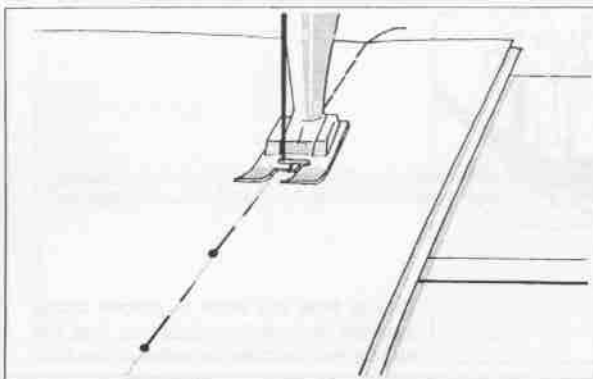

Basting

- Stitch width: 4
- Stitch length: 1½–4
- Needle position: left
- Automatic: Blindstitch [VVV] (2)
- Drop feed control: sewing

The magic needle has two eyes, one above the other. The lower eye is threaded for regular sewing. For basting, thread the upper eye.

Choose stitch length according to material and work, not too short or the basting may not easily be removed.

It is important to pin first, especially for cross stripes that have to match up exactly.

To secure the threads

Sew a few stitches with zz on O at the beginning and end of seam.

This is how the material is placed under the foot.

Important! The basting stitches do not form in the centre of the foot but only at the left hand swing of the needle.

Place the basting line at the left side of the foot. (Holding the work taut from the front and rear ensures correct guiding.)

Buttonhole
foot 033

Needle: 80-70
Thread: 30 or 50

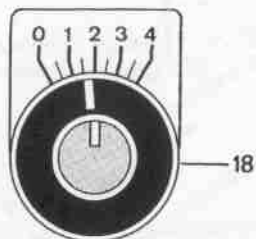

Adjustment of the Buttonhole

Two mechanical spring settings have been built-in for the buttonhole: one for zigzag 1,75 satin stitch for the beads of the buttonhole, the other for zigzag 3-3½ width for the bar tacks at each end of the buttonhole. By turning the zigzag knob slightly the spring settings can easily be felt.

Zigzag 1,75 (Spring setting)

Sewing the Buttonhole

Mark desired buttonhole length on material. Set the required buttonhole length with the guide on the buttonhole foot.

Move needle downwards to foot level and check that needle comes to middle of foot opening. If not do one stitch, turning handwheel by hand. But **never change zigzag or needle position.**

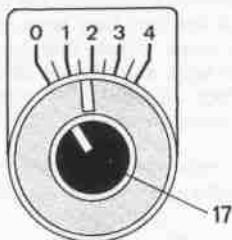
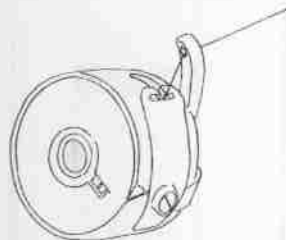

Needle Position: left

For sewing a buttonhole, thread bottom cotton through hole in finger of bobbin case.

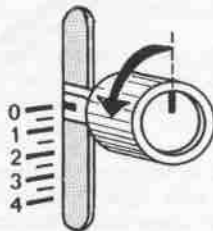

The buttonhole satin stitch spacing can be accurately set with the stitch length adjusting knob (19).

Turn knob (19) clockwise to the right until it stops. The marking line on the knob is vertical (stitch length = 0). Then you can set the satin stitch spacing - depending on material and thread - by turning knob (19) to the left.

It is best to check the satin stitch spacing on a piece of spare material before starting to sew.

1. Satin Stitch: Sew first bead of buttonhole to required length. Set needle in work in the middle of the foot. Lift foot. Turn work completely clockwise. Lower foot again.

1. Bar Tack: Lift needle out of work. Set zigzag to approx. 3 width (using spring setting). Hold work firmly. Sew stitches for bar tack.

2. Satin Stitch: Lift needle out of work. Set zigzag back on to 1,75 (using spring setting) and sew satin stitch for second bead.

2. Bar Tack: Lift needle out of work. Adjust zigzag again to width approx. 3 (using spring setting). Hold work firmly. Sew stitches for bar tack.

Finishing off: Set zigzag on 0 and sew a few stitches, still holding work firmly.

Buttonhole with Re-Inforcing Cord

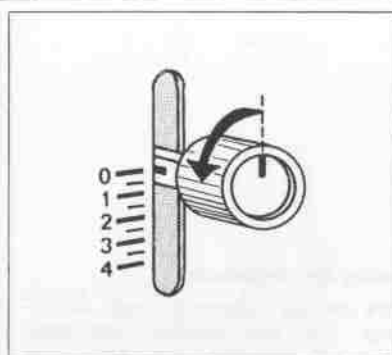

Set the buttonhole satin stitch

With knob (19) the stitch density can easily be regulated to suit the material. It is recommended to make a trial buttonhole on a remnant of the material to be used. The method of adjusting is the same as for the satin stitch. (Page 10)

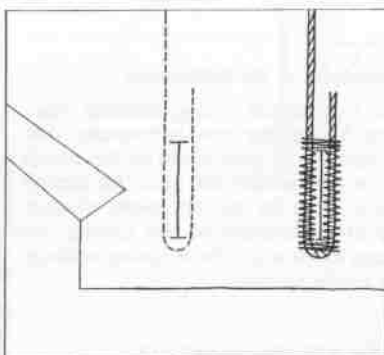

So that the loop of the inserted cord will reinforce the buttonhole where the button will pull, place the work to be sewn so that the edge of the material lies in front of the sewing foot and not behind.

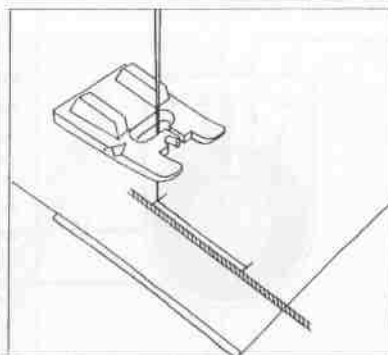

Lay the cord to be inserted to the left of the needle, so that when the sewing foot is lowered it will be in the left hand groove of the foot. Sew satin stitch for the first bead. Finish first bead with needle in work and to right of the cord and lift foot.

How to sew the buttonhole with reinforcing cord

Set machine. Lower needle to the raised foot and make sure that it is in the centre. If not do one stitch by turning the hand wheel towards you, bringing the needle to the centre. Under no circumstances should the zigzag or needle position be changed. Place the work to be sewn under the foot and set the needle exactly at the beginning of the buttonhole. Do not lower the foot yet.

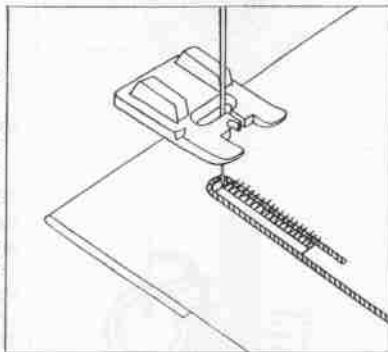

Hold cord in left hand and turn work clockwise with right hand until cords are parallel. Lower foot so that first bead now lies under right hand groove of foot. Continue sewing as described.

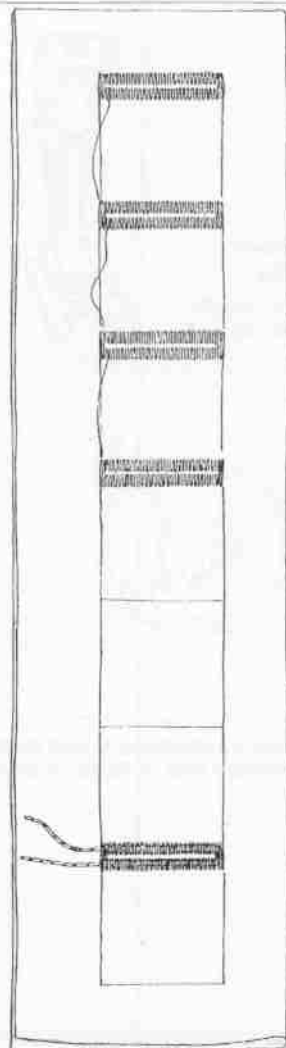



Zigzag foot 000
Needle: 80-70
Thread: 50



Patching with running stitch

Needle position: centre
Drop feed control: sewing

1st run

Stitch width: $1\frac{1}{2}$ -2
Stitch length: $1-1\frac{1}{2}$
Automatic: zigzag WWWW (1)

Do not cut off damaged part but baste the new patch on right side of work, and sew it on with a small zigzag.

2nd run

Stitch width: 4
Stitch length: almost 0
Automatic: Running stitch (3)

Now sew over patch edge with running stitch. Take care to oversew edges correctly.

3rd run

Stitch width: 0
Stitch length: 1
Automatic: straight stitch ---- (0)

Along inner edge of running stitch sew a straight stitch. Cut away damaged part. (Straight stitch makes the trimming much more easy.)

Modern "Darning" with running stitch

Stitch width: 4
Stitch length: almost 0
Needle position: centre
Automatic: Running stitch (3)
Drop feed control: sewing

Always underlay a fine fabric. Sew 2-5 rows of running stitch (according to the type of material).

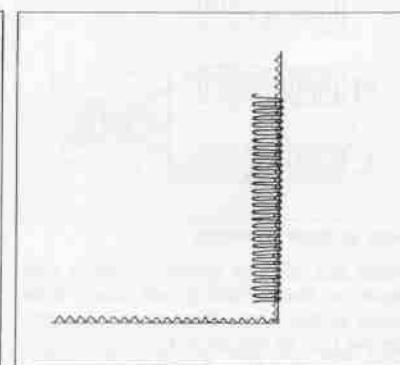
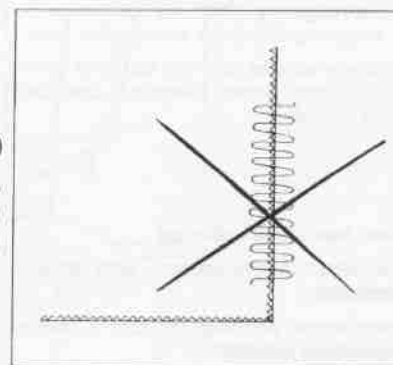
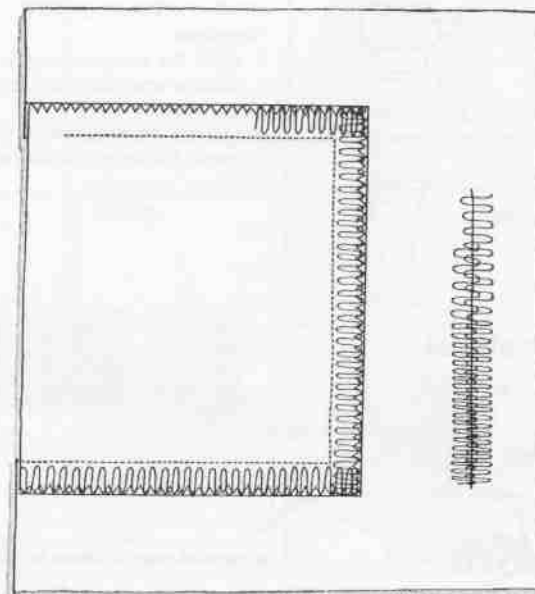

Oversew edges correctly: See diagram. Running stitch should not overlap the edges.

Darning



Small
darning foot 285
Needle: 80-70
Thread: 50

Darning material

Stitch width: 0
Stitch length: 0
Automatic: straight stitch ----- (0)
Drop feed control: lowered

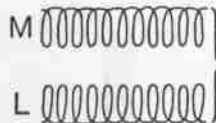

How to darn correctly

Make the turning points of each row blunt or the stitching will draw little holes at the ends. Beginners may prefer the L or M movement.
Take care not to get circles.

The quick mastering of this work depends on regular guiding.

Therefore:

- Hold the hoop correctly.
- Always work from left to right (as when writing).
- Move work lengthways (not sideways) for selvage and weftway.

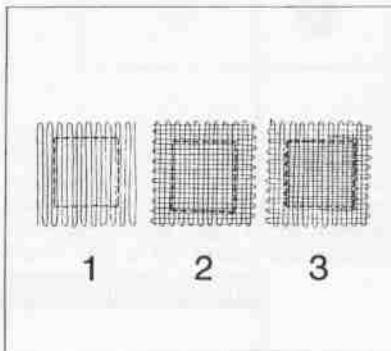

A careful darn is done in 3 runs

1. Weftway.
2. Selvage way. (Not too dense or it becomes too thick around the hole.)
3. Same way as 2nd run but only over hole itself losing threads in 2nd run of stitching.

Main faults when darning

Frequent thread breaking - work guided **irregularly**.

Poor stitch (looping on top) - work moved **too quickly**.

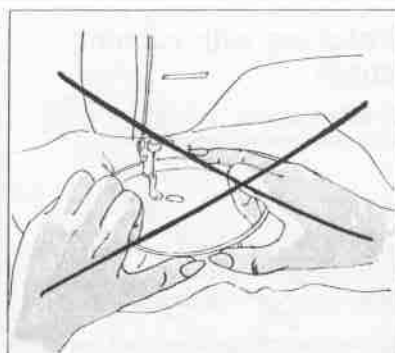

When wrong side of work is "grainy" work moved **too slowly**.

How to hold hoop correctly

Not like this ...
this would produce irregular guiding with frequent thread breaks.

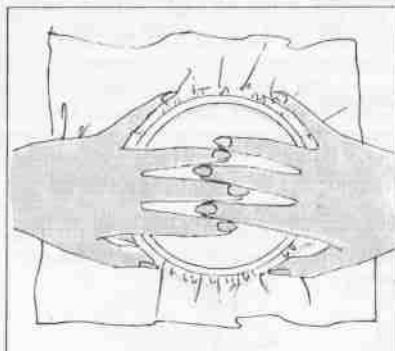

... but like this.
What is to be guided must be firmly held.

Thumb facing the frame (slightly bent) side of little finger to the frame.
Starting position of the fingers as in the picture - opposite one another.

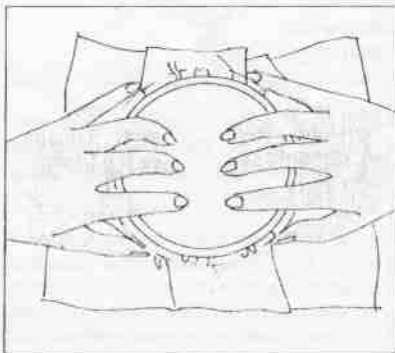

Then pulled back a little.

The frame is **guided** however by the outer fingers.



Small
darning foot 285
Needle: 80-70
Thread: 50

Darning fine socks (also sleeves)

Stitch width: 0
Stitch length: 0
Automatic: straight stitch ----- (0)
Needle position: centre
Drop feed control: lowered

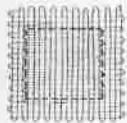

It is obvious here that we do the 1st stitch run sideways and the 2nd run lengthways as we cannot turn the frame to another angle.

Wrong

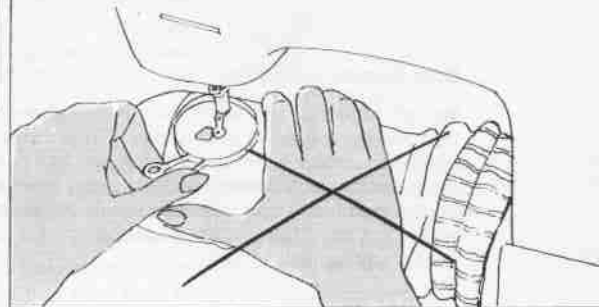

Correct

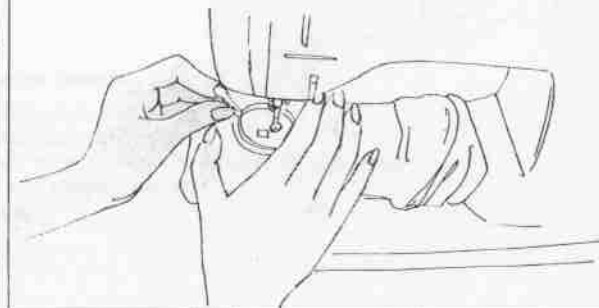

With the right hand keep the area of the hole taut over the hoop. Thumb on extreme point of free arm.

Dear Bernina Customer,

We are sure you will enjoy your Bernina even more now that you have learned how to use it. This modern machine has an enormous potential. The second half of your Bernina book describes supplementary jobs that can be carried out on the Bernina. Some of them require extra accessories which are provided against additional cost. Your Bernina dealer will be glad to help.



Wool
darning foot 272
Needle: 80—70
Thread: 50
(For Terry Cloth
use 4 strands of
untwisted thread
instead of wool)



Darning of Woollens and Terry Cloth (towels)

Stitch width: 3—4
Stitch length: 0
Automatic: zigzag WWWW (1)
Drop feed control: lowered

Thread machine with matching thread.
Lay the wool in the slot of the presser
foot. The wool will then be guided
automatically.

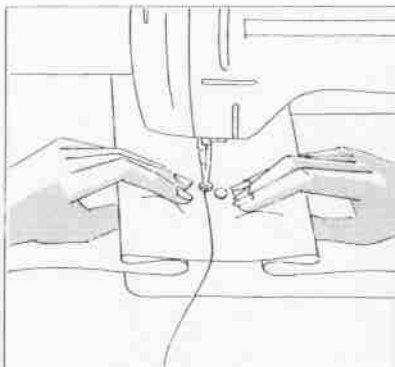

1st run: Applying the wool

Start the work on the left, a little above
the hole. Stitch down the wool with one
or two stitches, and leave the needle
down.

Hold the area to be mended correctly.
Do not push the work to and fro on the
machine, but hold it taut while you
guide. When applying the wool bear
the following points in mind:

- Do not make too deep a curve at the
ends or the threads will be too far
apart.
- Apply the wool threads close together
over the hole (they may even lie
slightly over one another). Always
move work sideways (left to right
and vice versa).

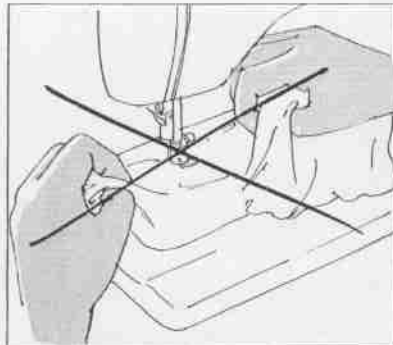

Model 807, 810 only

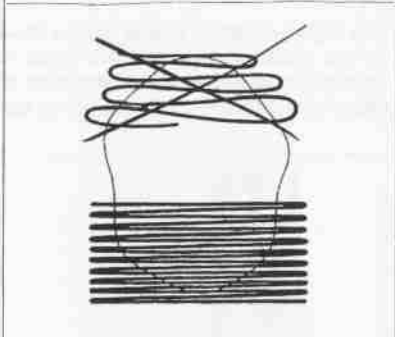

2nd run: Oversewing the threads

Cut the wool at the presser foot. Hold
work again as before. Now sew across
the new wool threads with zigzag. The
zigzag rows should not overlap nor lie
apart from one another.

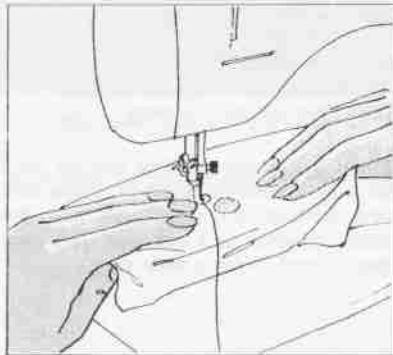

Model 807, 810 only

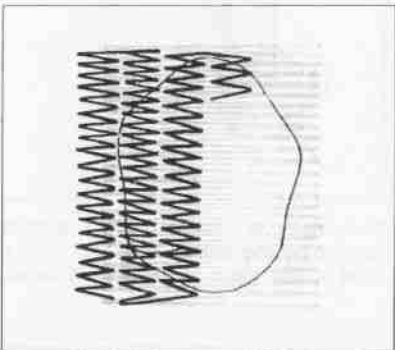

Sewing on buttons

Button presser foot 152

Needle: 80
Mercerised sewing
thread: 50
or
embroidery
thread: 30

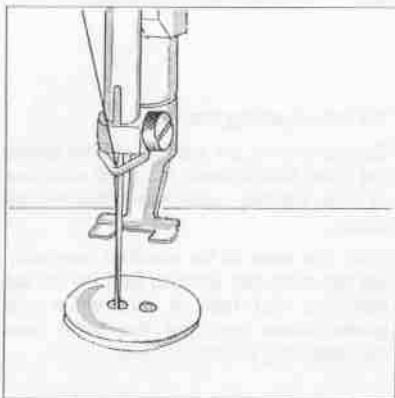
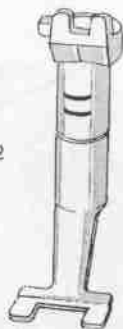

Sewing the button on

Stitch width: 3—4
Stitch length: 0
Needle position: left
Automatic: zigzag WWWW (1)
Drop feed control: lowered

Every zigzag presser foot can be used for button sewing. However, those who sew buttons on often will find the button presser foot superior. The wide gap in front allows a clear view.

Slide piece of work under the presser foot. Place button on marked spot and let needle into the left hole. Then lower presser foot.

The zigzag width is nearly always 3—4 as the distance between the holes is usually the same, with the exception of decorative buttons.

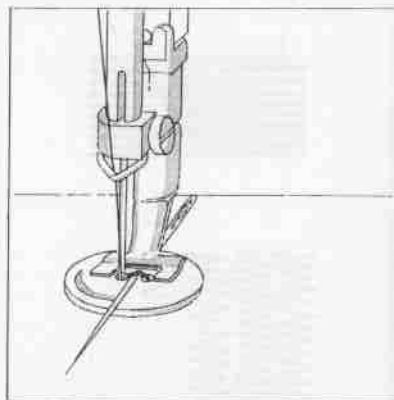

Turn hand wheel until needle is in its highest position. Adjust zigzag width and make a trial stitch turning hand wheel by hand. You will then see, whether the width of the zigzag is correct.

If necessary, adjust zigzag. Now sew the button on. Less stitches are needed for light weight materials. To finish raise needle. Set zigzag to 0 and sew some fastening stitches.

If a shank is required, lay a darning needle on the button and sew over it. (Add a few more stitches than usual.)

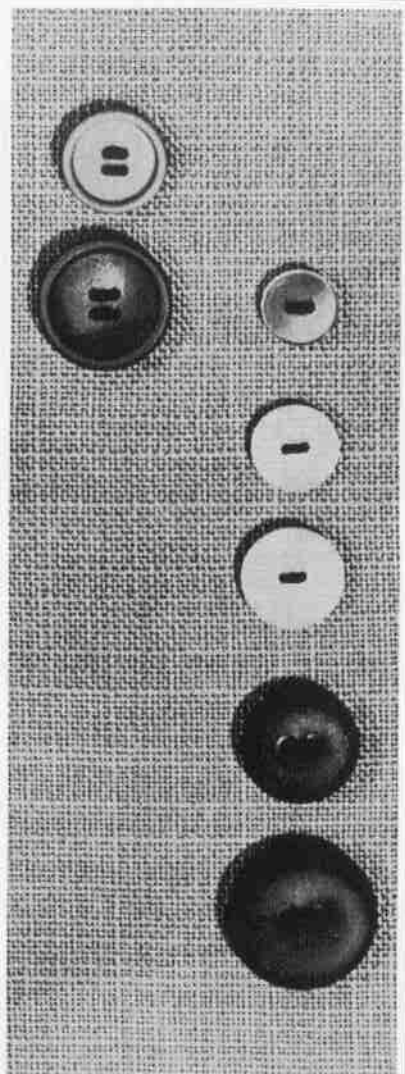

Method:

Lower drop feed control and set machine. Leave zigzag on 0.

Zipper foot 007

Needle: 80

Thread: 30



Stitch width: 0
Stitch length: 1½—2
Automatic: straight stitch----- (0)
Needle position: according to side set left or right
Drop feed control: sewing

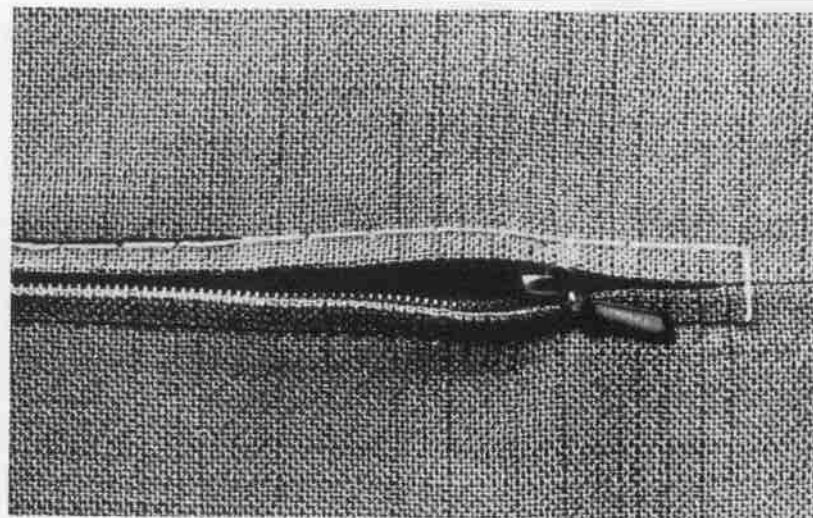

The zip is basted in by short stitches so that the teeth are entirely covered by the material. Open the zip before you sew it in.

Sew down each side from top to bottom, once with the needle position right and once with the needle position left.

Hint: The easiest way to insert a zip

Sew seam first with a very long straight stitch or basting stitch, then press open. (Damp if necessary.) Finish the edges then unpick the seam. (When stitches are very long they are easy to remove.)

When inserted like this both sides remain even and are not distorted.

Tailor tacking

Tailor tacking foot
419

Needle thread:
according to
material and
colours

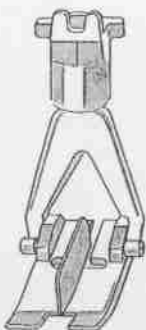

Automatic: zigzag WWWW (1)
Needle position: centre
Drop feed control: sewing

Tailor tacking with sewing thread

Needle: 80
Stitch width: $1\frac{1}{2}$ —2
Stitch length: 4

Tailor tacking with basting thread (especially for wool materials)

Use basting thread for top thread only;
and normal sewing thread for the bobbin.

Needle: 90
Stitch width: 2
Stitch length: 4

Tailor tacking with darning thread (for thin materials)

Needle: 70
Stitch width: $1\frac{3}{4}$
Stitch length: 4

Important preliminary

1. First set zigzag and put needle at highest position. Only then attach presser foot (to ensure needle is not damaged).
2. Remove thread from the tension discs and thread round the selector lever 13 as in diagram. When work is finished replace thread between the tension discs.

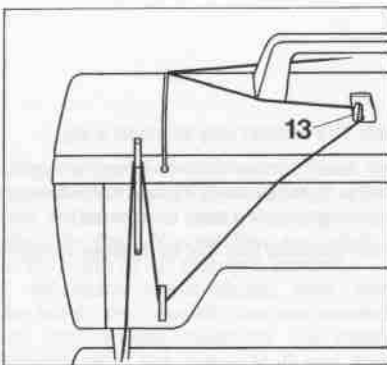
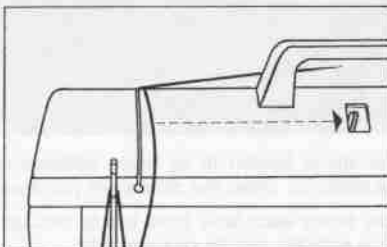
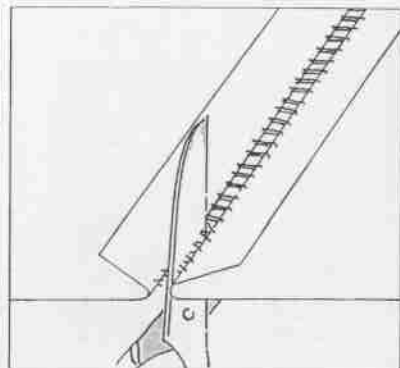
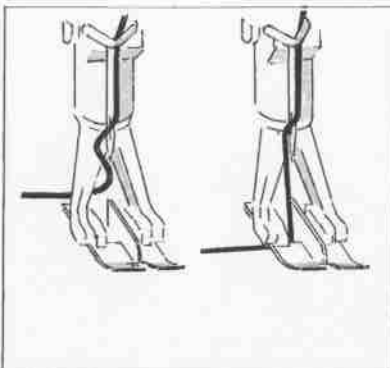

Draw thread to the rear under the presser foot. Before starting to sew always lay the thread sideways under the presser foot.

Pull both sides of the material gently apart and cut through the threads.

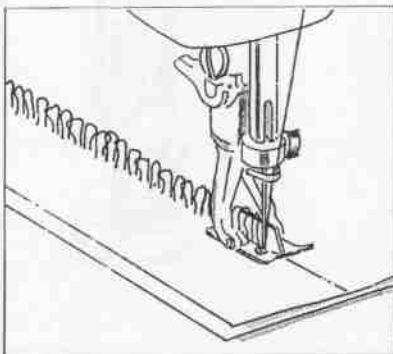

When tacking by hand one works directly alongside the pattern. It is to be recommended when working by machine (saves time) to transfer the pattern onto the material with chalk and then remove the pattern. It is understood that the pieces of material should be pinned down first before basting to prevent slipping.

A pattern can be transferred onto the fabric with the aid of the tailor tacking foot, this forms the necessary loops.

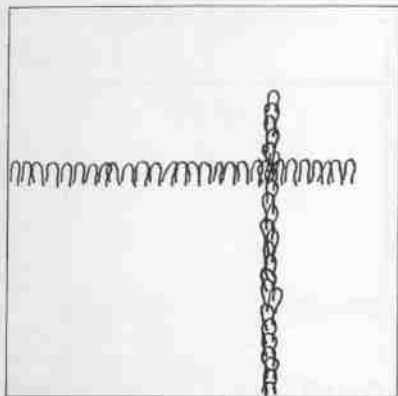

Mark the corners this way ...

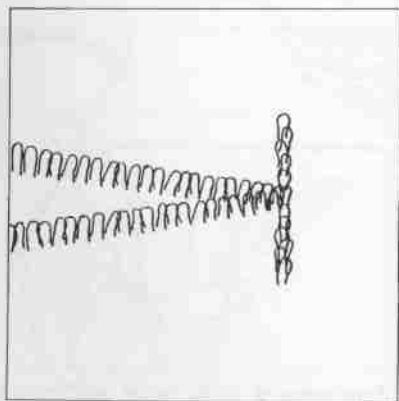

... and the darts like this

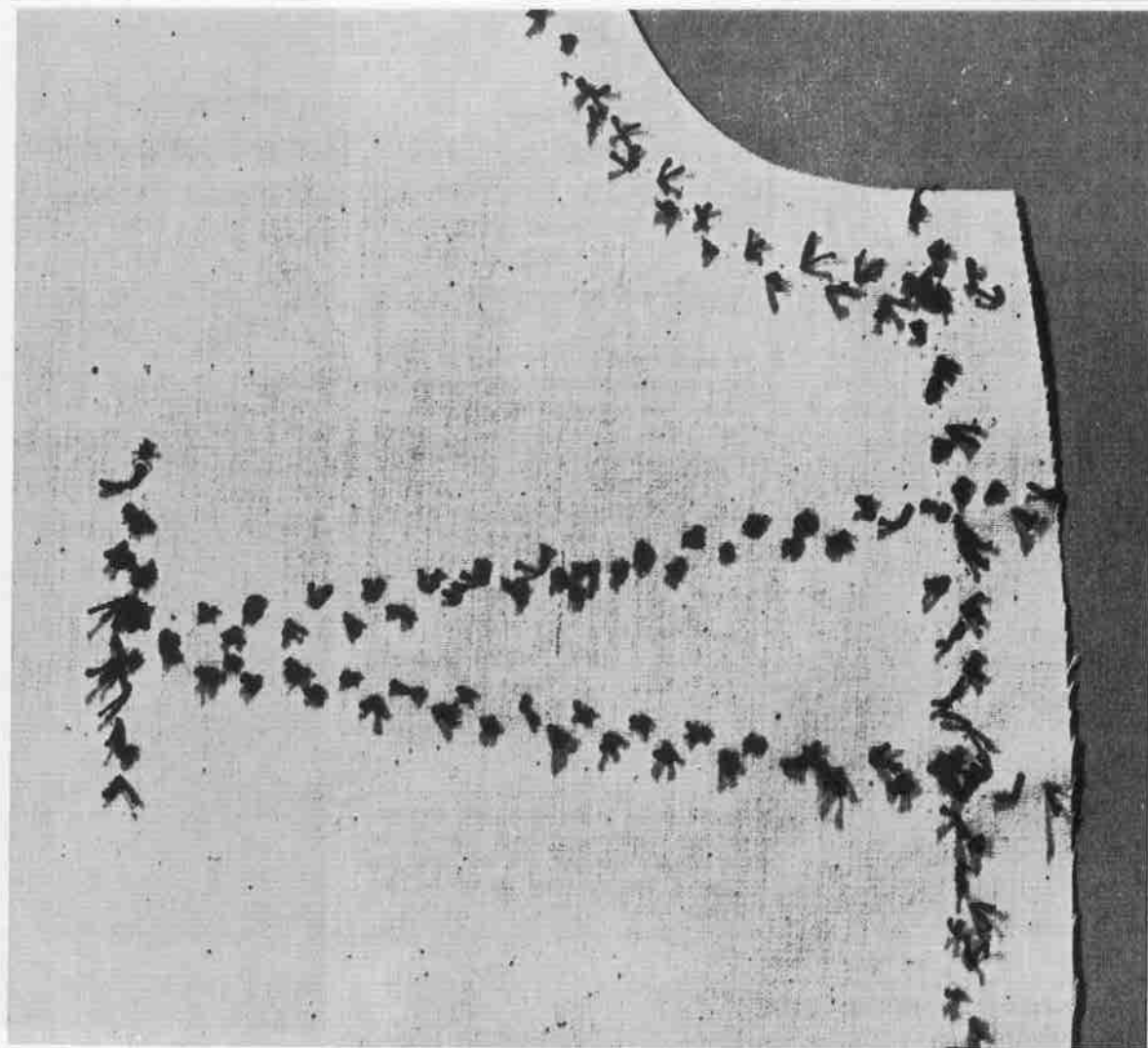

The Hemmer



Hemmer 003
Needle: 80—70
Mercerised sewing
thread No. 50

Stitch width: 0
Stitch length: $1\frac{1}{2}$ —2
Automatic: straight stitch----- (0)
Needle position: centre
Drop feed control: sewing

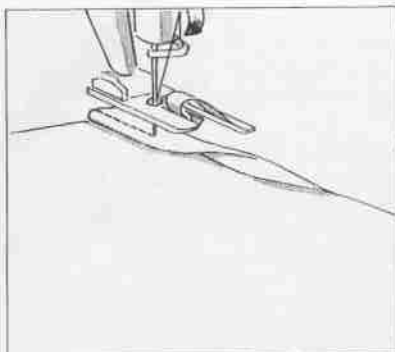

To begin sewing: Fold edge of fabric twice (not too wide). Lay work under the presser foot and sew a few stitches.

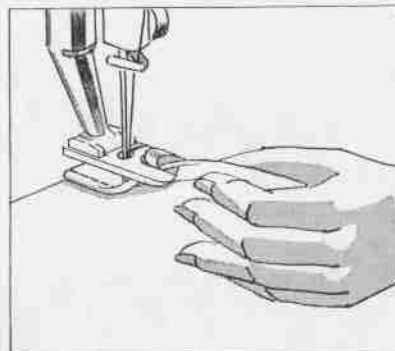

Leave needle in the fabric and lift presser foot. Tautly hold the first fold under the presser foot with the left hand and draw it through the spiral on the presser foot.

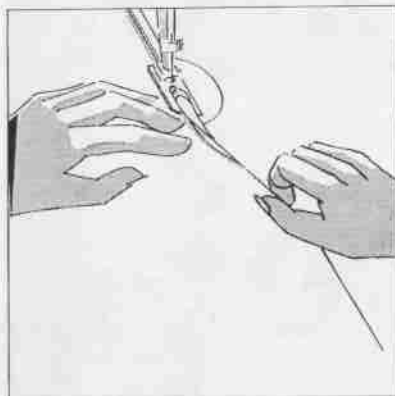

How to guide the work

When guiding fabric hold it taut and lift it slightly. The edge of the fabric must be vertical and run through the machine in a straight line.

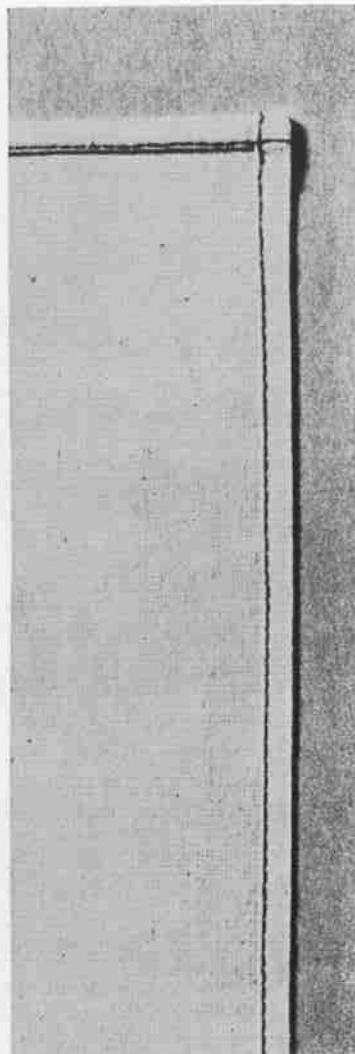

The corners: These are sewn in two stages as follows:

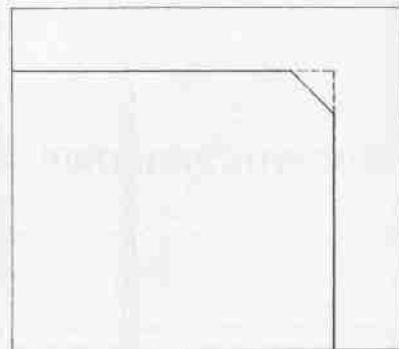

First cut a little off (not too much otherwise they will pull apart). Sew first seam.

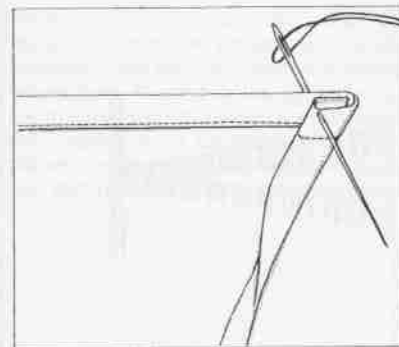

Fold edge of fabric twice and draw a strong thread through by hand.

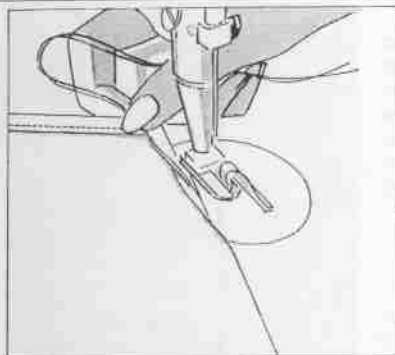

Hold corner (together with thread) with thumb and forefinger of the right hand and lay the work near the presser foot.

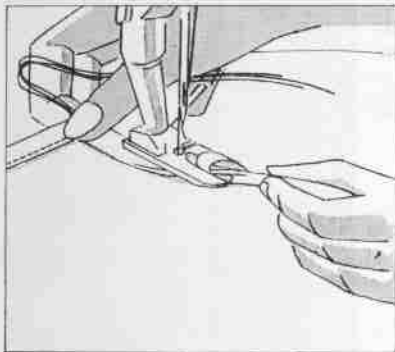

With the left hand hold the first fold near the presser foot and draw through the spiral on the foot. Still holding the fabric taut draw it towards you and lay the end under the needle. Stick the needle in and lower foot.

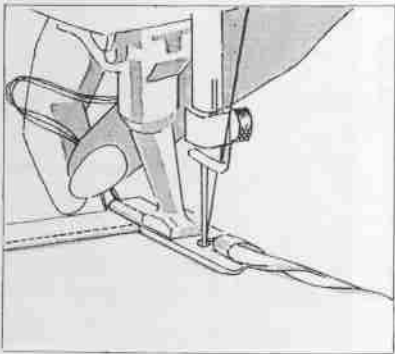

To facilitate sewing on the corner one should hold the tacked thread together with the sewing thread and pull gently until the presser foot no longer lies on the corner.



Shell hemmer 168

Needle: 80—70

Mercerised sewing thread No. 50

Stitch width: 4
Stitch length: 2½—3
Automatic: zigzag WWWW (1)
Needle position: centre
Drop feed control: sewing

Use the same method as for normal hemming.

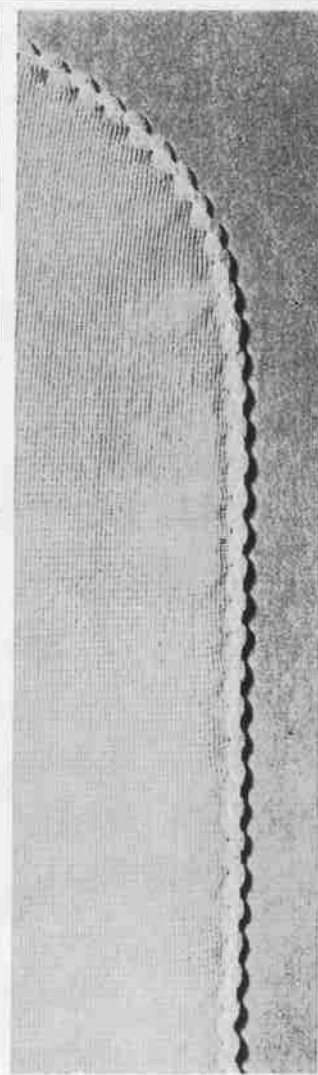

The Lap Hemmer (Feller)



Lap hemmer 174

Needle: 80—70

Mercerised sewing
thread No. 50

Stitch width: 0
Stitch length: $1\frac{1}{2}$ —2
Automatic: straight stitch ---- (0)
Needle position: centre
Drop feed control: sewing

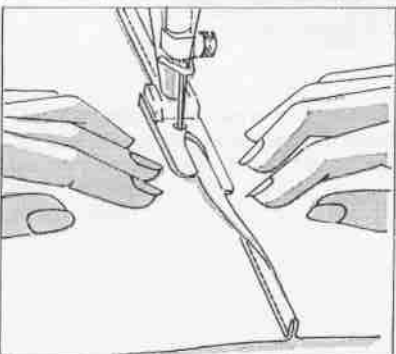
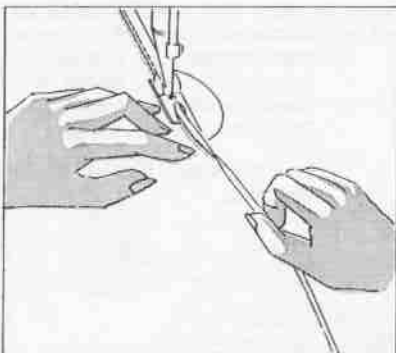
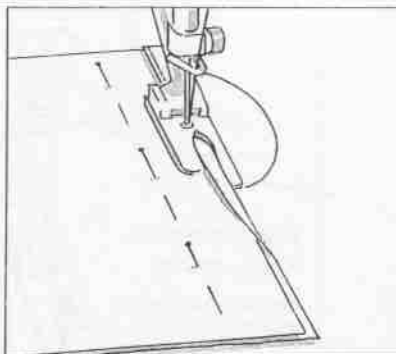

First operation:

Pin both pieces of fabric together so that the piece underneath projects by 3 mm ($\frac{1}{8}$ "). Fold overlapping piece over the top piece and slide it under the presser foot. Sew a few stitches. Leave needle in the fabric, lift presser foot and guide fabric into the foot.

When sewing make sure that the same width of material enters the feller all the time. Guide the fabric as you do when sewing a hem.

Second operation:

Now iron seam well, guide it again into the feller and sew the second row of stitches. Pull fabric slightly sideways on both sides of the feller.

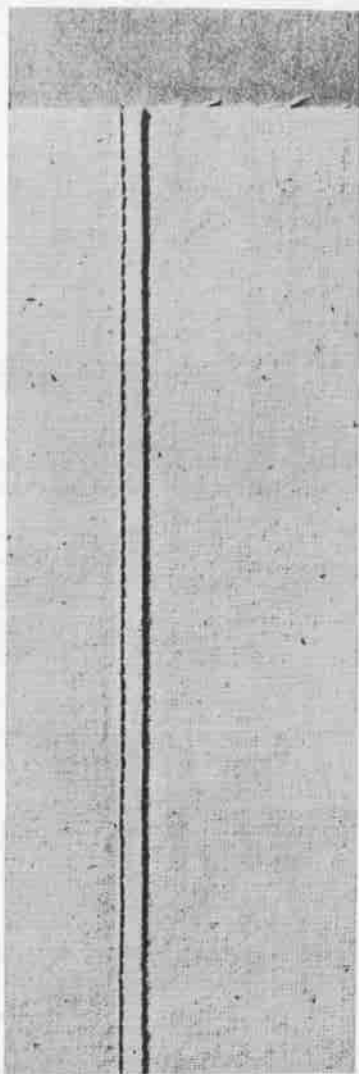

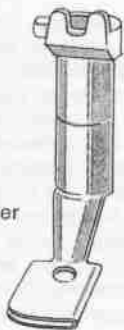

Presser foot: Gatherer
179
Needle: 80—70
Mercerised sewing
thread: 50

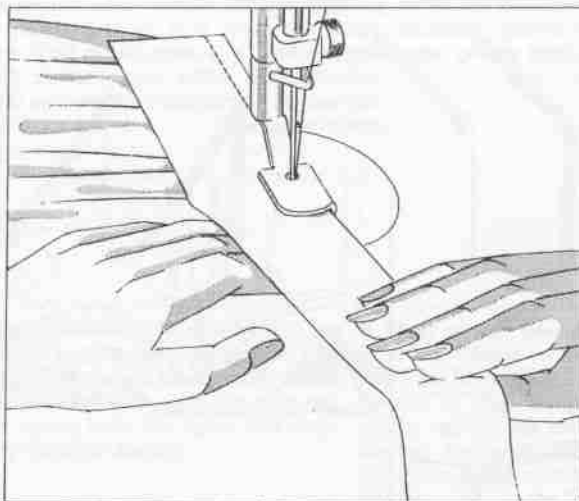

Stitch width: 0
Stitch length: 1½—4
Automatic: straight stitch ---- (0)
Needle position: centre
Drop feed control: sewing

The flat piece of material is inclined to slip out of the slot. In order to avoid this the work should be guided as shown in the illustration, by holding the lower piece with the left hand and the upper piece with the right hand. Always pull slightly towards the right hand corner of the presser foot.

Calculation: The amount of gather depends on the length of the stitch. The longer the stitch the tighter the gather.

For tight gathering the upper piece of material can be pulled a little.

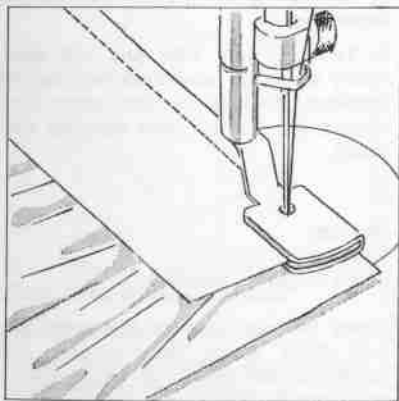

The material to be gathered always lies **under** the foot and the flat piece in the slot.

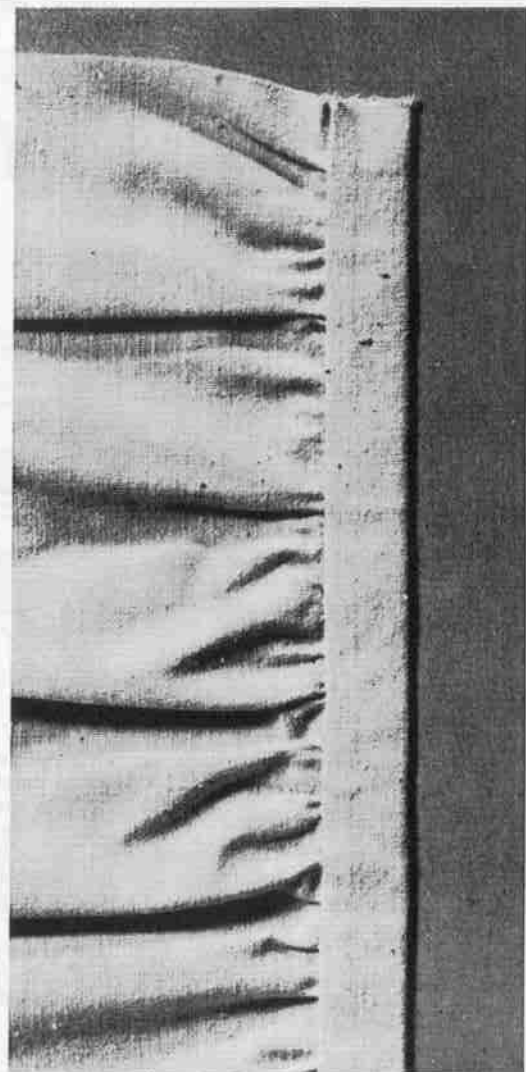

Applique work

Embroidery foot 030

Needles: 80—70

Thread:
Embroidery thread
No. 50

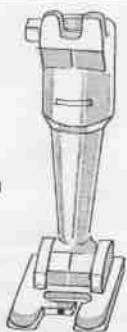

Automatic: zigzag WWWW (1)
Needle position: centre
Drop feed control: sewing

Guiding with the frame: The left hand must hold the frame steady, because often the frame is guided during sewing with this hand only.

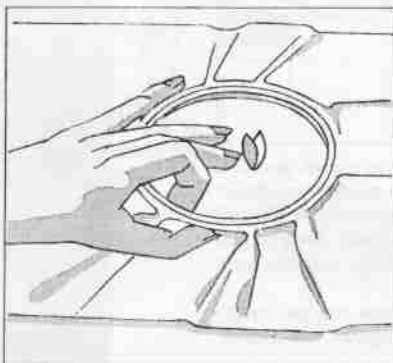

First put your hand in the position as when darning. Then draw forefinger back to the inner edge of the frame. Extend the middle and rings fingers. Your hand now has complete control of the frame and the best possible freedom of movement.

Notice: Do not place the forefinger parallel to the thumb, otherwise the movement of your hand will be restricted.

Guiding without frame: «You can only guide the work if it is held lightly.» Nevertheless, it is essential to hold the material itself rather taut. This is the only way the work can be turned as the design requires.

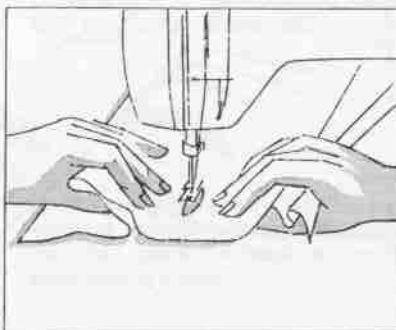

Correct: Place thumbs under the material. Make a fold if the piece of work is large (see diagram). Guide near the presser foot.

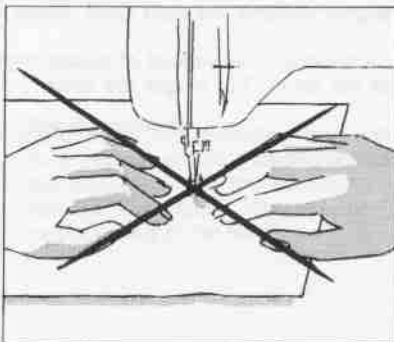

Incorrect: This way is incorrect as pressure on the work will result.

Working sequence

Preparation: Trace design on the wrong side of the material with the aid of special tracing paper. See that the motive is in reverse. The design can also be traced onto iron-on Vilene and the Vilene ironed on to the wrong side of the material. (Especially recommended for rough and irregularly woven fabrics are difficult to draw on.) If a design that is to be used often trace on thin Vilene and then transfer it onto the material. Vilene can be tacked on to a garment to stiffen it if desired.

1st run:

Stitch width: $\frac{1}{2}$ —1
Stitch length: $\frac{1}{4}$ — $\frac{1}{2}$

Tack material for applique onto the right side.

1. Sew along the traced lines on the wrong side.

2. Turn to right side and cut away neatly along the sewn lines any surplus applique material. (At the same time remove the frame.) Hold scissors correctly.

2nd run:

Stitch width: $1\frac{1}{2}$
Stitch length: almost 0

Cover the cut edge on the right side with Satin Stitch. Sew corners and small curves, stitch by stitch (using hand wheel).

Finish by tracing the lines through that were not applied and sew from the right side.

Guiding the work

You may work with or without the frame; however, taut material can be guided more easily.

Important: The machine feeds automatically but only in a straight line. For curves the work must be guided by hand i.e. the frame or the material must be lightly held by one or both hands and should not be pressed onto the sewing table.

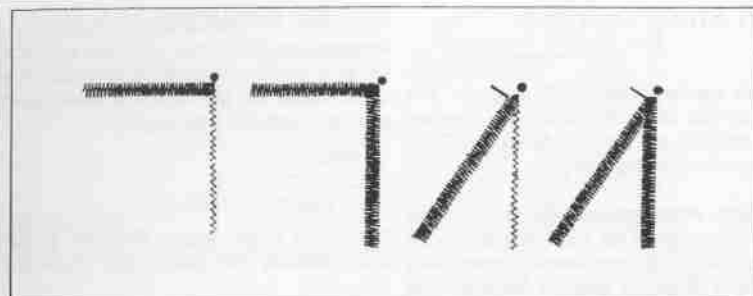

Sewing the corners

1. Rectangular corner: Put the needle on the outer edge, turn the work and continue sewing. The corner will now be oversewn.

2. Pointed corner: Stop sewing $\frac{1}{2}$ cm ($\frac{1}{8}$ ") in front of the corner. Then turn back zigzag while sewing on 0. Raise presser foot and turn the material. Set zigzag onto $1\frac{1}{2}$ again and carefully continue sewing.

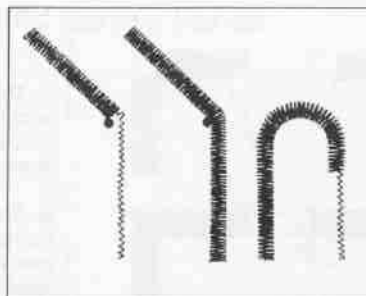

3. Blunt corner: Sew until the needle is in the middle of the angle. Then sew out from centre, replacing the needle in the middle after every stitch, raising the presser foot and turning the work slightly. **Curves:** Using the same method as for blunt corners.

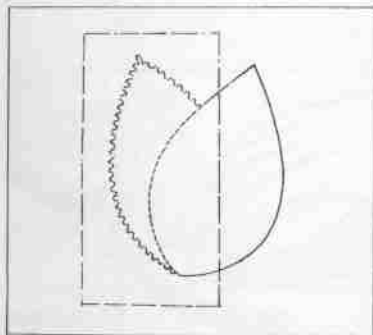

Multi-coloured applique work

The lower part:

1. Only this part of the applique material should be tacked on. Sew around: Where the colours overlap use straight stitch and zigzag the other contours.

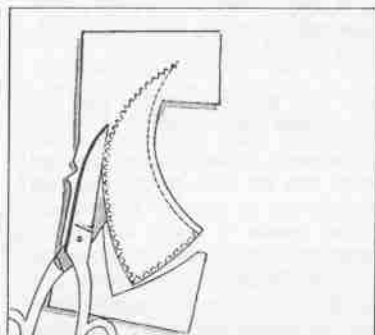

2. Trim away surplus applique material, cutting as closely as possible to zigzag stitches. Where a straight stitch has been used leave $\frac{1}{2}$ cm ($\frac{1}{8}$ ") beyond stitches.

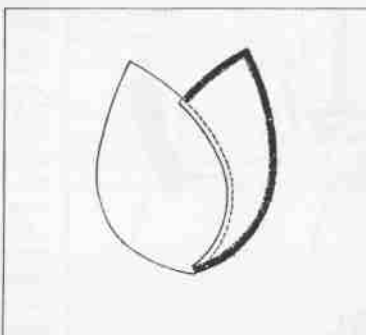

3. When covering the contours leave the straight stitched edge uncovered. This will be covered again by the next part.

Top part: Complete in the usual manner for applique work.

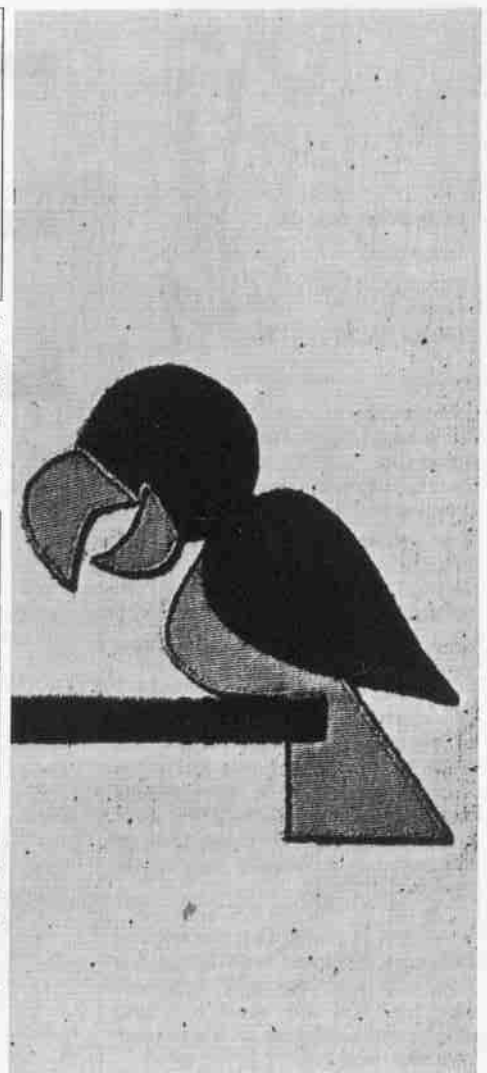

Satin Stitch embroidery



Embroidery foot 030

Needle: 80

Thread:
Embroidery
thread No. 30

Stitch width: 4
Stitch length: Satin Stitch
Automatic: zigzag WWWW (1)
Needle position: centre
Drop feed control: sewing

Remember the following

when embroidering over satin stitch and ornamental stitch seams:

The stitch length for embroidery is to be adjusted to a short length. The material may block progress when the foot moves over a seam already embroidered. By guiding the work close to the foot and assisting its movement the difficulty can be removed.

If the foot is almost over the edge of the seam, hold the material back a little otherwise the foot will glide away and this will result in a long stitch (which will look as if a mistake has been made).

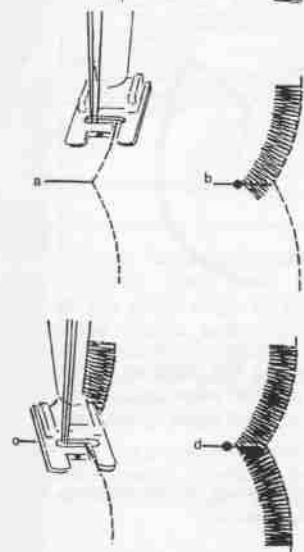
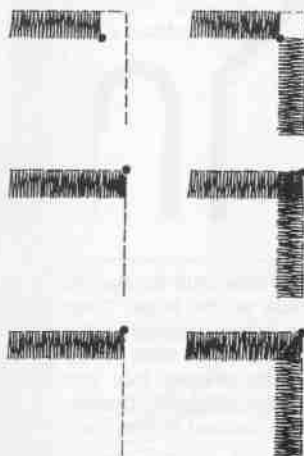

Satin Stitch corners

1. Open corner: Sew until a space the width of the stitch is left in the corner. Place needle on the inside edge. Turn work and continue sewing.

2. Closed, oversewn corner: Sew to the corner. Put needle on the outer edge, lift presser foot and turn work. Lower foot again and continue sewing (help a little by placing finger near the foot, see embroidery over satin stitch or embroidery seams).

3. Corner with diagonal design (rectangular): Sew to the corner. Place needle on the outer edge. Lift foot, turn sewing work. Needle position, left or right (according to design) sew zigzag on 0. Lower foot. **Now whilst sewing slowly** turn zigzag onto 4 again; sewing slowly!

4. Corner with diagonal design (for festoonery): Needle position left!

a) Lay the work under the foot so that the design can be seen in the slot that runs lengthwise. **b)** Sew to the corner, i.e. till the needle is about to make a stitch from the left on the line drawn to assist you. **c)** Raise foot, turn work and turn zigzag to 0. Lower foot again. Make sure that the design appears once again in the slot that runs lengthwise. **d)** During sewing turn the zigzag again slowly onto 4; sew slowly!

Broder scallops

Preparation: Draw the scallops with the aid of a cardboard stencil onto the material. Mark all the corners with white crayon. Underlay with paper.

1st run:

Stitch width: 4

Stitch length: almost 0

Sew satin stitch seam. Remove paper and carefully cut round the scallops.

2nd run:

Stitch width: 2½—3

Stitch length: 1—1½

Oversew edge with zigzag. At the same time guide a pearl cord along the edge making sure that it does not slide over or under it.

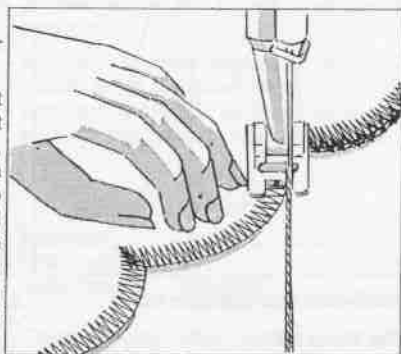

Note: The machine feeds in a **straight** line and not in curves. The broder cord must therefore be held **straight** and the scallop edge must be guided on this straight line. **Guide slowly and near the foot.**

Straight border

Preparation:

Draw border line, underlay with paper.

1st run:

Stitch width: 4
Stitch length: almost 0

Sew satin stitch seam. Remove paper and cut away surplus material.

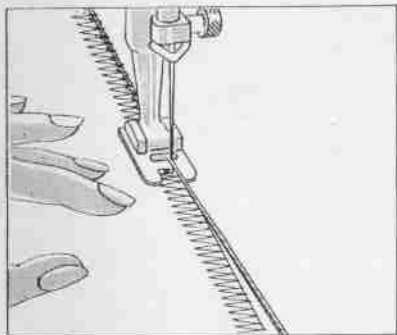

2nd run:

Stitch width: 2½—3
Stitch length: 1—1½

Oversew edge with zigzag. At the same time guide through pearl cord (No. 8 three- to five-ply) taking care that it neither slides over nor under the edge.

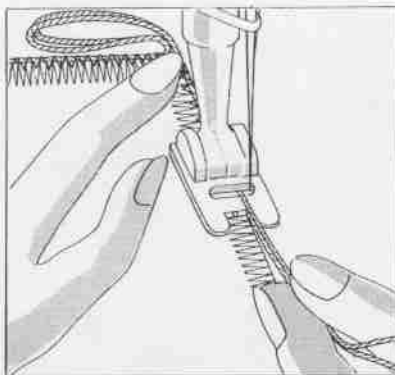

Corner: Sew to the corner. Lower drop feed control. Sew three stitches using the hand wheel. Leaving the needle in the work at the inside edge, raise foot, turn work. Make a loop with the cord, lower foot and sew further three stitches. Raise drop feed control and continue sewing carefully. Pull on the loop until the foot no longer lies on the corner. To make loop disappear pull the ends of the cord. (See diagram.) Push corner stitch over the corner and continue sewing.

Narrow border

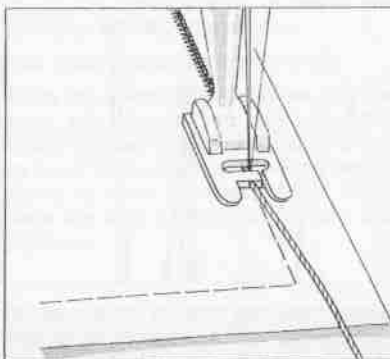

1st run:

Foot: Embroidery foot
Stitch width: 1½
Stitch length: ¼
Needle position: centre

Draw pearl yarn No. 5 or 8 (according to material) through the hole of the embroidery foot. Sew seam with satin stitch. Cut surplus material away carefully.

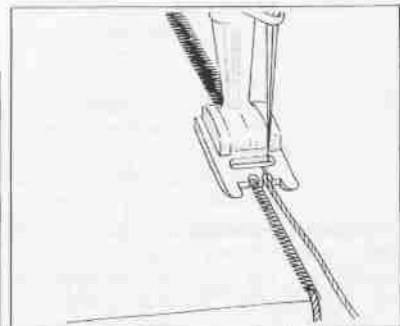

2nd run:

Foot: Small buttonhole foot
Stitch width: 2—3 (according to material)
Stitch length: almost 0
Needle position: centre

Now completely cover the first satin stitch seam with a second. Lay the work under the foot in such a way that the satin stitch seam is in the **left** groove of the foot. Place the cord (mostly 1-ply) into the **right** hand groove of the foot. In this way the yarn is joined exactly to the edge. Make the corner in the same way as with the wide border.

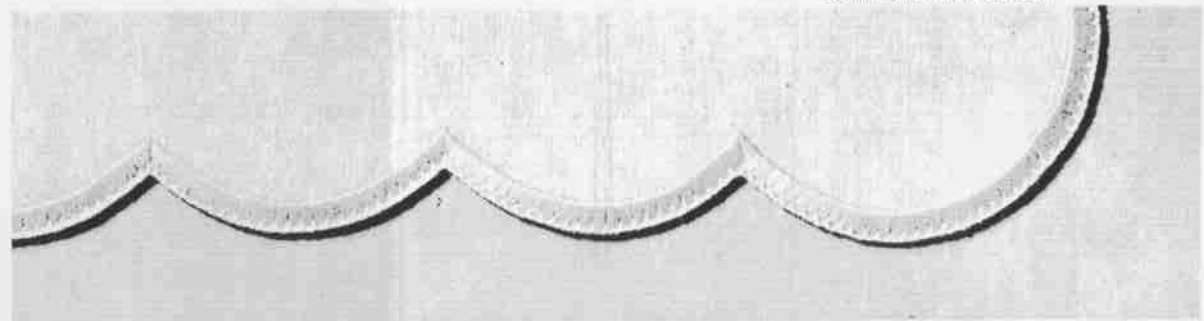

Double needle

Embroidery foot 030

Thread:
Embroidery thread:
No. 30 or 50

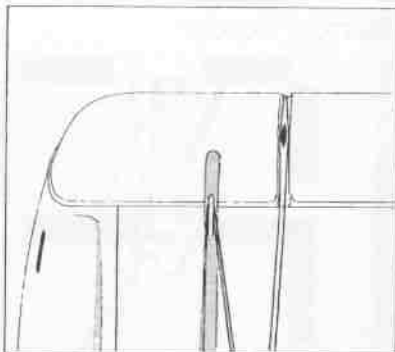

Double needle

These special needles produce very beautiful effects on delicate materials, whether shades of one colour or different colours.

When threading through the thread tension, make sure that one of the threads goes left and the other right of the tension disc.

Adjustment

Automatic: As desired
Needle position: centre
Drop feed control: Sewing

Double needle

Stitch width: $2\frac{1}{2}$
Stitch length: $\frac{1}{4}$ —1
(according to pattern)

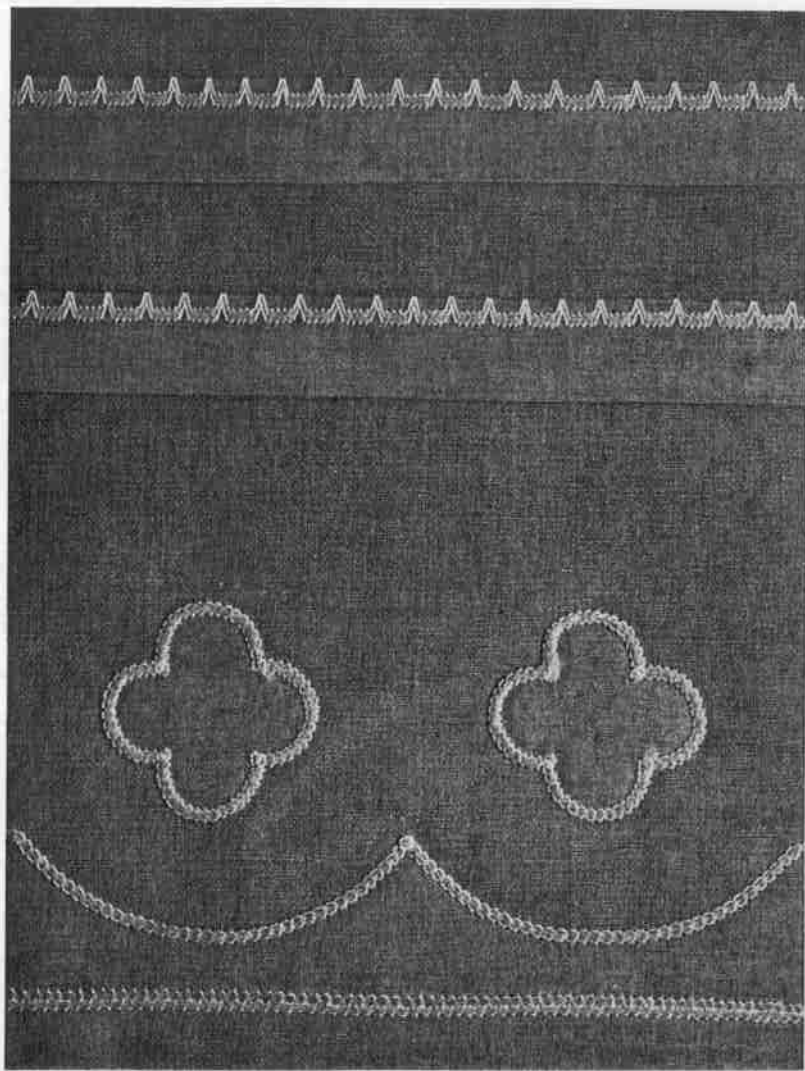
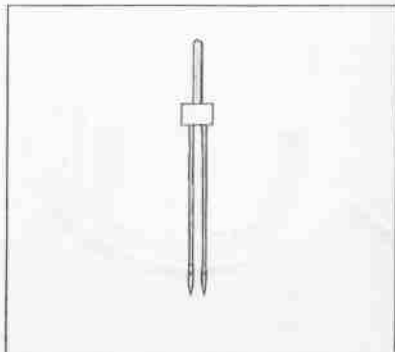

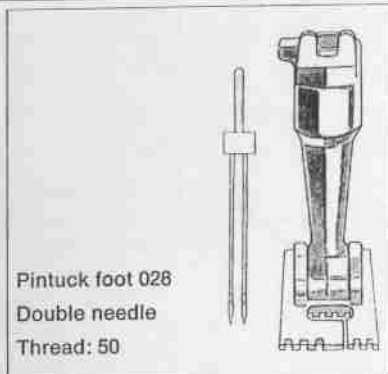

Koho-ommel

Stitch width: 0
Stitch length: about 1½
Automatic: straight stitch ----- (0)
Needle position: centre
Drop feed control: sewing

To sew pintucks, 2 top threads are needed (for double needle). When threading the machine take care that the two threads are not twisted together, but bring them singly from take-up lever to the needles.

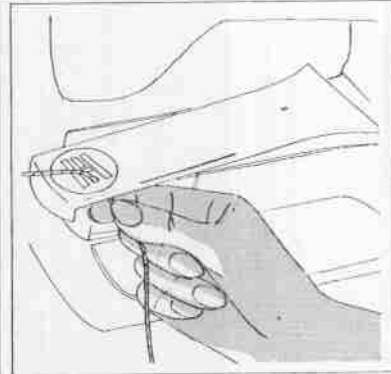

The gimp is threaded like this:
model 807, 810

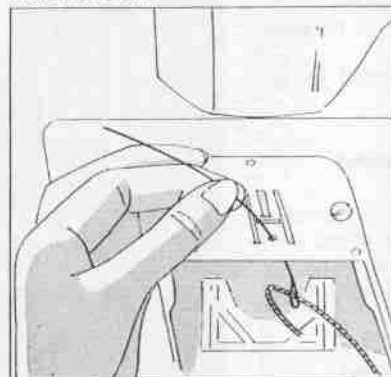

The gimp is threaded like this: model 817

The quickest way to set up the machine for pintucking

Insert bobbin case. (Do not bring up lower thread yet.) Insert and thread the twin needle.

Thread the gimp through the hole in the needle plate (the free arm cover can be removed for this) and finally bring up the bottom thread and clip on the pintuck foot.

The gimp is threaded like this:

The regular spacing between the tucks is controlled automatically by the grooves on the underside of the foot. (When embroidery is eventually to be sewn between tucks, then a width of exactly 1 presser foot is required.)

Sewing Pintuck Corners

Because of the double needle, corners cannot be turned at right angles in one stitch, as with a single needle.

You should therefore proceed thus:

Bring the points of the needles into the work. Lift presser foot. Half turn work. Lower presser foot. Turn balance wheel by hand to do one stitch leaving needle points in work. Lift presser foot. Complete the turn. Lower presser foot and continue.

Fancy Patterns with double needle

(Remove the cord)

Stitch width: 0—2½
Stitch length: about ¼
Needle position: centre
Automatic: as desired
Drop feed control: sewing
Thread: 30 or 50

When designs are sewn in between or close to the tucks, use the **pintuck foot** for automatic guiding. For twin needle embroidery without pintucks, use the embroidery foot.

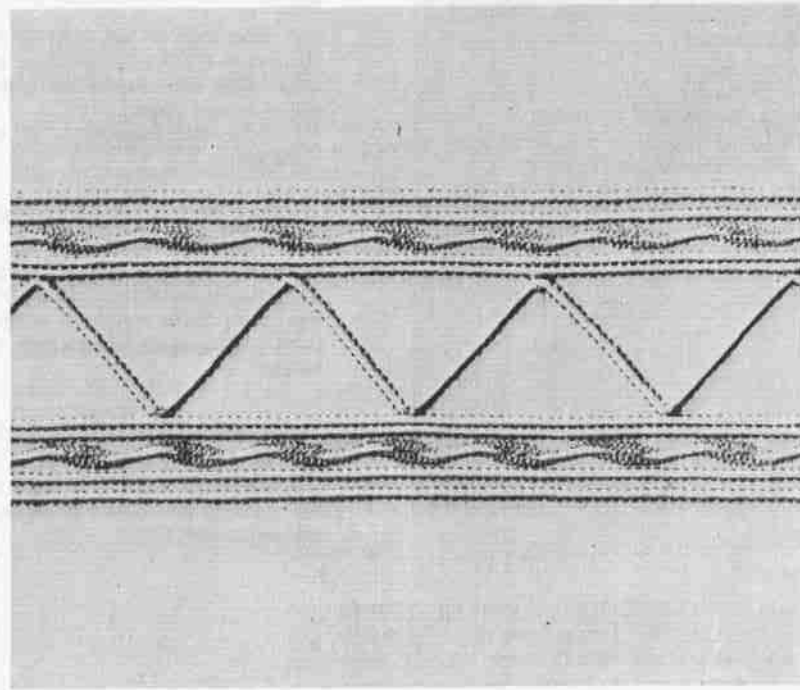

Hemstitching (for fine fabrics)

Embroidery foot 030

Needle: Single
hemstitch needle

Thread:
Embroidery thread
No. 30 or 50

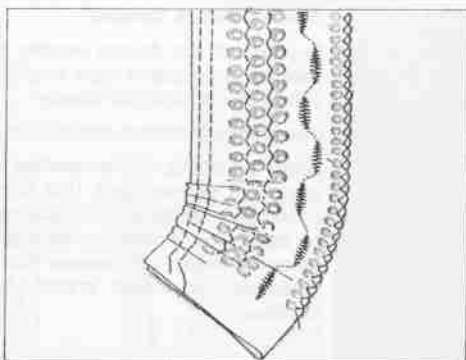
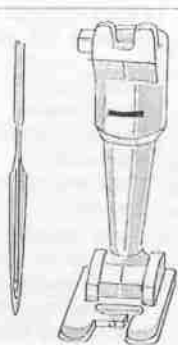

Single hemstitch needle

Adjustment

Stitch width: 2
Stitch length: 1
Needle position: centre
Automatic: zigzag WWWW (1)
Drop feed control: Sewing

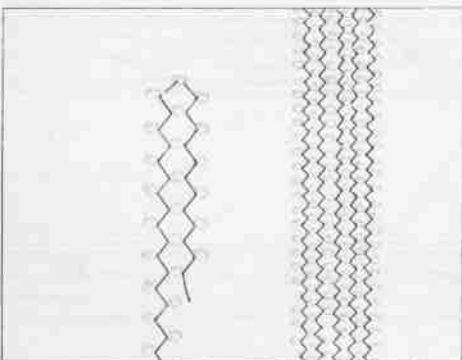

Method

Sew first row of stitching. Leave tip of needle in work, turn and sew second row (the needle will then pierce holes first row on one side).

Ruche

Iron bias strip of organdy in two. Sew hem stitches at the desired distance over the folded edge. Sew the ornamental stitch in between with a normal needle.

An Entre-deux (insertions) is worked in the same way.

Applique with Pre-Embroidered Material (use Organdie double)

Hemstitch a piece of fine material in the manner described until you get a trellis effect. With this trellis make a normal applique. Finish by cutting away background material from under trellis.

Trellis work with metallic thread (Lurex)

Can be used as a border (e.g. for a stole). A very attractive effect is brought about if a double metallic thread is led through the hole in the embroidery foot.

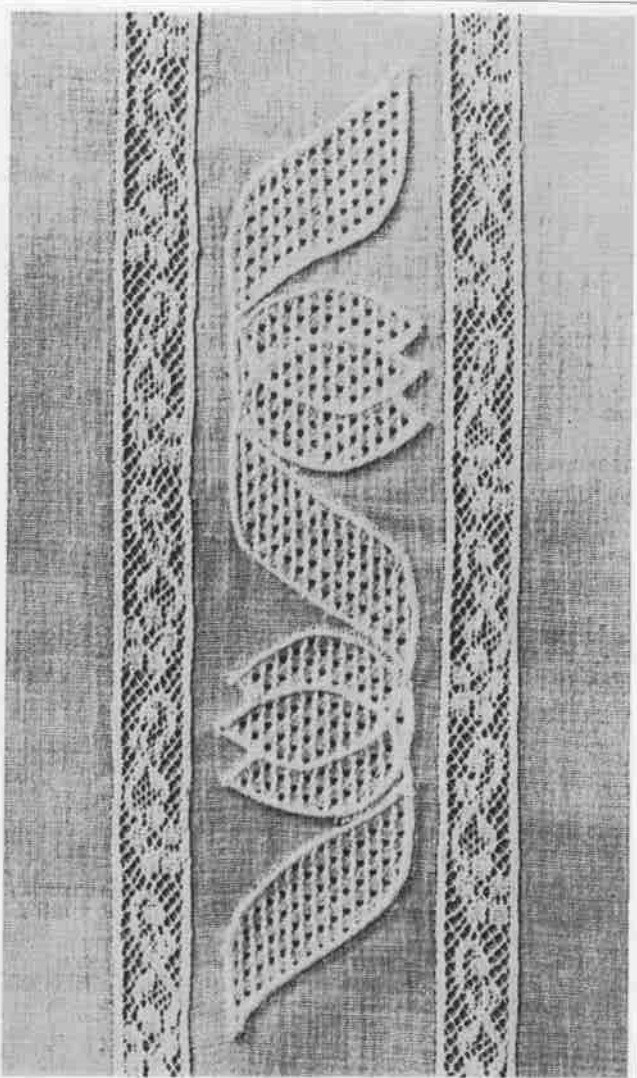

Sewing foot 000
Needle: Double
hemstitch needle

Thread:
Embroidery
thread No. 50

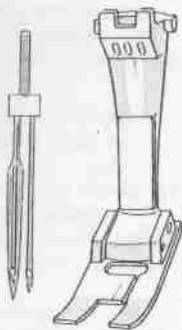

Double hemstitch needle

Automatic: 0
Needle position: centre
Drop feed control: Sewing

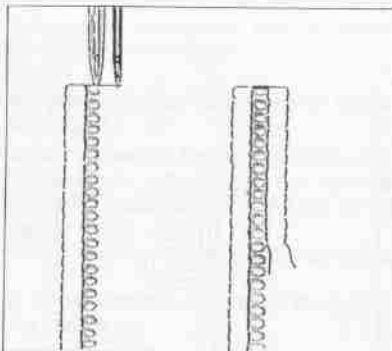

Ordinary Hemstitching

Stitch width: 0
Stitch length: $1\frac{3}{4}$
Automatic: straight stitch ----- (0)

Sew first hemstitch row of embroidery, raise needle and foot, turn work. Put wide needle in the first hole of the previously sewn row and resume sewing. In order that the hemstitch needle can sew exactly into the holes of the first seam, do not hold back work.

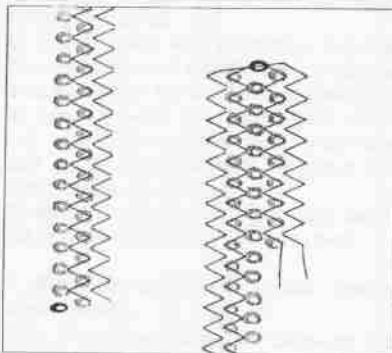

Zigzag Hemstitching

Stitch width: $1\frac{3}{4}$
Stitch length: $1\frac{3}{4}$
Automatic: zigzag WWWW (1)

Sew the first side of the hemstitch row of embroidery. Just pierce the last left stitch, then turn back the hand wheel again and raise the presser foot. Turn work. With the wide needle stitch through the previously pierced hole and continue sewing. Do not hold the sewing work back.

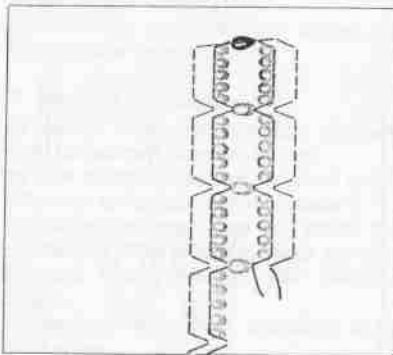

Fancy Hemstitching

Stitch width: $1\frac{3}{4}$
Stitch length: $1\frac{3}{4}$
Automatic: Blindstitch VVV (2)

Worked in the same way as the zigzag hemstitching.

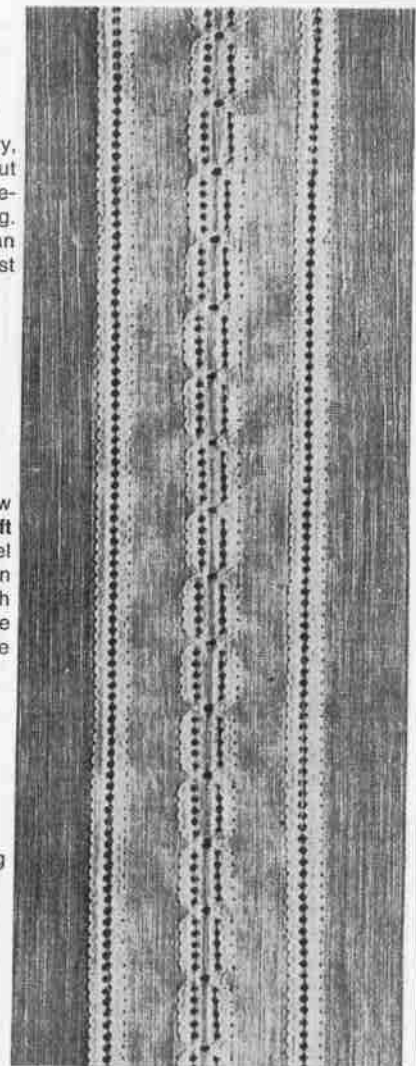

Monograms

Without foot
Needle: 80—70
Thread:
Embroidery
thread 50

Stitch width: 4—2
Stitch length: 0
Automatic: zigzag WWWW (1)
Needle position: centre
Drop feed control: Lowered

Stretch the material tightly in the frame as the work is to be carried out without a foot. **Important:** Lower the foot lever just the same as usual, otherwise the top thread tension will remain open and unattractive work will result. If the bottom thread is drawn through the finger of the bobbin case the work will run more smoothly (as with button-hole sewing).

Method

Bring up the bottom thread through the material, sew a few straight stitches and cut the thread ends. Set zigzag. Place needle ready to begin and make a test stitch. The drawn line must be in the middle of the zigzag.

Move the frame as through wanting to write with it. **Do not stop turning frame until the monogram is complete.**

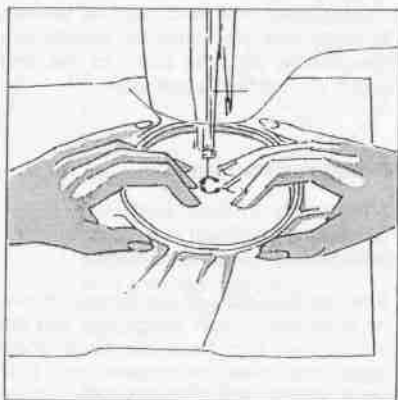

Guiding the work

Hold frame as when darning. Do not move fingers while working, as jerky movements produce uneven monograms.

To produce a perfect monogram a great deal depends on how the frame is held. The more securely the work is held the better the result.

Important: Allow the machine to run rather quickly; however, the frame should be guided slowly and steadily.



1. Generally, most breakdowns are caused by incorrect handling of the machine. If breakdowns do occur then examine whether:

- the needle is inserted properly (the **flat** side of the needle must be at the back);
- the correct needle is being used (see needle and thread table);
- the machine is cleaned properly. Lift free arm cover plate and remove sewing lint;
- the hook race is clean and oiled;
- there are pieces of thread caught between the thread tension discs or under the bobbin case spring;
- hand wheel is secured properly.

2. If the upper thread breaks. Can have the following causes:

- top thread is too tight;
- use of inferior needles (buy them preferably from a Bernina dealer);
- needle inserted wrongly. Flat side must be at the **back**;
- the needle is blunt or crooked;
- poor quality or knotted thread. Thread has dried out due to long storage;
- the needle plate hole is pitted by needle and needs repolishing (bring free arm cover plate, resp. needle plate to authorized Bernina dealer).
- hook point is damaged (call authorized Bernina dealer).

3. If bottom thread breaks. Can have the following causes:

- the bottom thread tension is too tight;
- bobbin is crushed and jammed in the bobbin case;
- needle hole in throat plate is damaged by the needle and needs repol-

ishing (call authorized Bernina dealer to change needle plate).

4. Faulty stitches. Can have the following causes:

- wrong needle. Use system 705 B only;
- needle is crooked or not inserted correctly (push needle right up in the needle bar!);
- low quality needle, roughly polished.

5. Needle breaks. Can have the following causes:

- needle clamp screw is not sufficiently tightened;
- the material was withdrawn towards the operator and needle bent (material should always be withdrawn to the rear);
- when sewing over **thick part** material was pushed whilst the needle was still in, therefore it bent, touched the throat plate and broke.
- when cheap cotton, irregularly twisted or even containing knots is used.

6. Seam irregularities. A bad uneven seam results:

- if thread remnants are between the thread tension discs;
- if thread remnants are under the bobbin case tension spring.

7. Machine runs slowly

- Motor does not function properly (call authorized Bernina dealer);
- foot starter does not function properly (call authorized Bernina dealer);
- use of low quality oil can block the movement. The machine must be dismantled and cleaned. Call Bernina dealer;
- machine has been standing in a cold room.

When you bring your machine to an expert, please take along accessories and foot starter.

Cleaning the machine. During sewing pieces of thread and fluff collect under the needle plate and around the hook. The cover plate of the free arm should be removed from time to time so that the sewing fluff can be cleaned away.

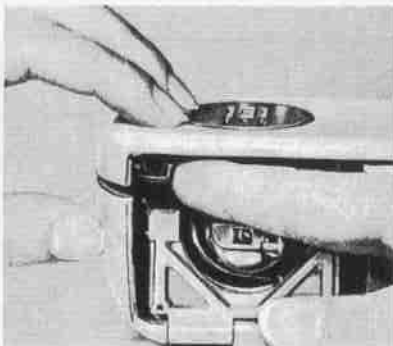

Take off cover-plate from free-arm. Remove presser foot or needle, open hinged cover. Then hold the cover-plate with the left hand press the release lever at the same time with the forefinger of the right hand.

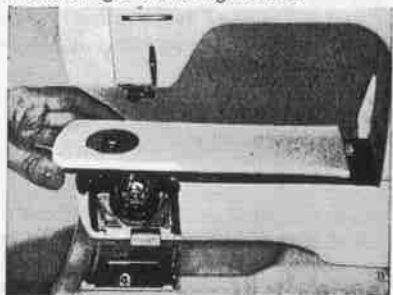

After removing the cover, the feed dog is free and can then be properly cleaned as also can the lower side of the needle plate on the arm-cover.

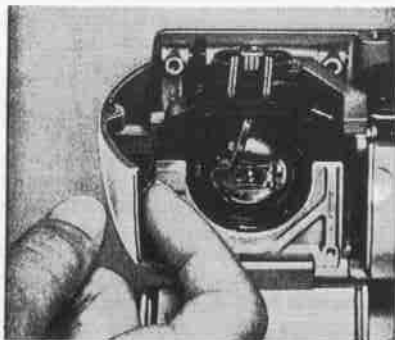

Cleaning and oiling the hook. Remove bobbin case. With the forefinger of the right hand press latch to the left. The locking bridge together with the hook race cover now be turned down.

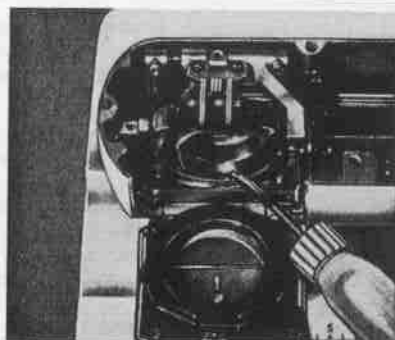

After cleaning pour a few drops of oil into the shuttle race. Insert the shuttle again with the left hand. Lock the bridge together with the shuttle race cover, making sure that the spring snaps back into position. Test by turning the handwheel as a precautionary measure. Replace arm cover and re-screw tightly. When the bobbin case is inserted the hinged shuttle cover can be closed.

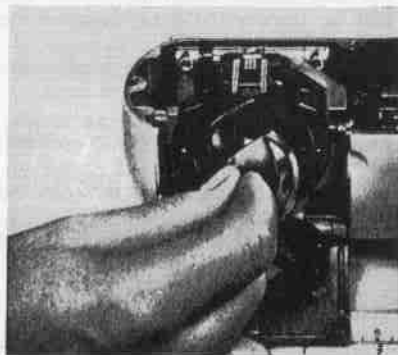

Now the hook can be taken out and the hook race cleaned with a small brush and cotton duster. Never use hard tools such as screwdrivers and scissors for removing thread particles.

If the machine has been standing in a cold room, it should be brought into a warm room about an hour before use, so that it can warm up to room temperature and the oil in the bearings will again become fluid.

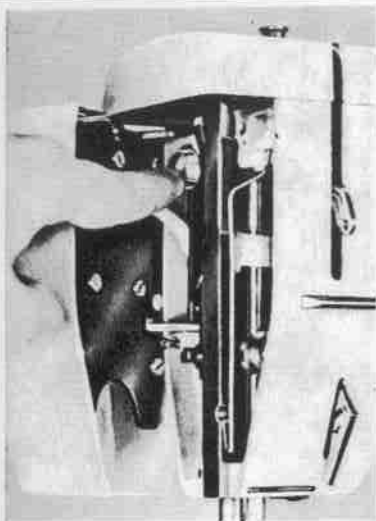

Removing frame cover (Model 807)

The frame cover is raised slightly under spring tension by pressing the release knob (see illustration) and can easily be removed.

Important note (safety regulations BEAB, OSHA and so on)

Please observe the sewing position while sewing. The moving needle is a source of danger (danger of injury to fingers).
The sewing machine should be disconnected from the power supply by pulling out the plug from the socket when changing the light bulb, the needle, presser foot, bobbin or needle plate, when stopping work without supervision and during servicing (cleaning).

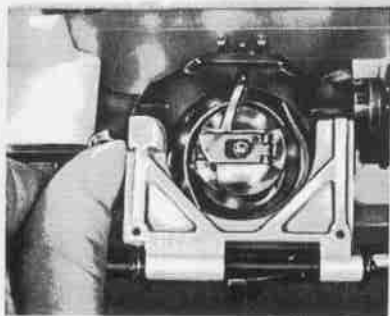

Cleaning and oiling the hook. Tilt head of machine to the back. Remove bobbin case. With thumb of left hand press latch to the left. The locking bridge together with the hook race cover can now be turned down.

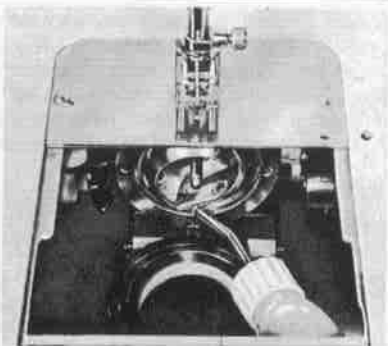

After cleaning pour a few drops of oil into the shuttle race. Insert the shuttle race again with the left hand. Lock the bridge together with the shuttle race cover, making sure that the spring snaps back into position. Test by turning the hand-wheel as a precautionary measure. Replace arm cover and re-screw tightly. When the bobbin case is inserted the hinged shuttle cover can be closed.

Insert bobbin case and close needle plate slide. Machine can be put in its proper position again.

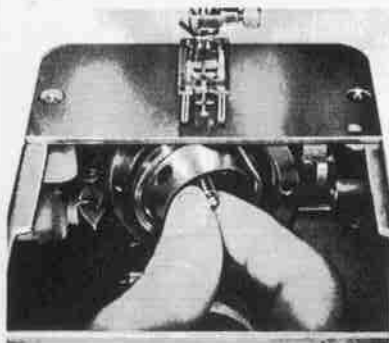

Now the hook can be taken out and the hook race cleaned with a small brush and cotton duster. Never use hard tools such as screwdrivers and scissors for removing thread particles.

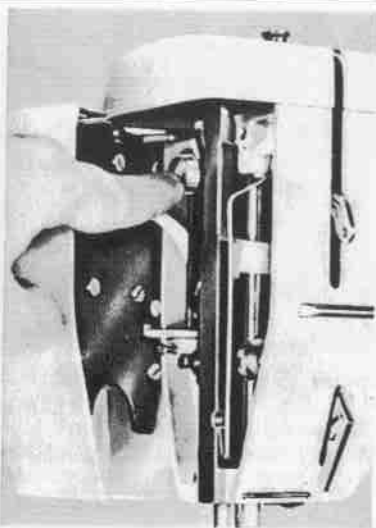

Removing frame cover

The frame cover is raised slightly under spring tension by pressing the release knob (see illustration) and can easily be removed.

Important note (safety regulations BEAB, OSHA and so on)

Please observe the sewing position while sewing. The moving needle is a source of danger (danger of injury to fingers). The sewing machine should be disconnected from the power supply by pulling out the plug from the socket when changing the light bulb, the needle, presser foot, bobbin or needle plate, when stopping work without supervision and during servicing (cleaning).

Address of my Bernina agency:

Genuine Bernina Parts

BOOK. M.B.G. 807 ENGLISH

Reorder # 39010203



Loc: WAL16 070300